



INSTRUCTION MANUAL

DUAL BAND TRANSCEIVER

IC-2730A IC-2730E



Icom Inc.

Thank you for choosing this Icom product. This product is designed and built with Icom's state of the art technology and craftsmanship. With proper care this product should provide you with years of trouble-free operation.

EXPLICIT DEFINITIONS

WORD	DEFINITION
⚠ DANGER!	Personal death, serious injury or an explosion may occur.
⚠ WARNING!	Personal injury, fire hazard or electric shock may occur.
CAUTION	Equipment damage may occur.
NOTE	Recommended for optimum use. No risk of personal injury, fire or electric shock.

About E-marking:

Detailed installation notes for Icom mobile transceivers to be fitted into vehicles are available. Please contact your Icom dealer or distributor.

Icom is not responsible for the destruction or damage to the Icom transceiver, if the malfunction is because of:

- Force majeure, including, but not limited to, fires, earthquakes, storms, floods, lightning, other natural disasters, disturbances, riots, war, or radioactive contamination.
- The use of Icom transceivers with any equipment that is not manufactured or approved by Icom.

IMPORTANT

READ ALL INSTRUCTIONS carefully and completely before using the transceiver.

SAVE THIS INSTRUCTION MANUAL— This instruction manual contains basic operating instructions for the IC-2730A or IC-2730E.

SUPPLIED ACCESSORIES

The following accessories are supplied with the transceiver.

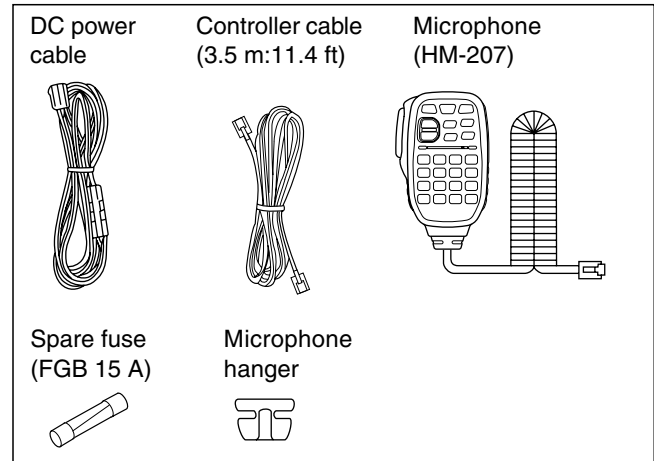

PRECAUTIONS

⚠ **DANGER HIGH VOLTAGE! NEVER** touch an antenna connector during transmission. This may result in an electrical shock or burn.

⚠ **WARNING RF EXPOSURE!** This transceiver emits Radio Frequency (RF) energy. Extreme caution should be observed when operating this transceiver. If you have any questions regarding RF exposure and safety standards please refer to the Federal Communications Commission Office of Engineering and Technology's report on Evaluating Compliance with FCC Guidelines for Human Radio Frequency Electromagnetic Fields (OET Bulletin 65).

⚠ **WARNING! NEVER** operate the transceiver while driving a vehicle. Safe driving requires your full attention—anything less may result in an accident.

⚠ **WARNING! NEVER** operate the transceiver with an earphone or other audio accessories at high volume levels. Continuous high volume operation may cause a ringing in your ears. If you experience ringing, reduce the volume level or discontinue use.

⚠ **WARNING! NEVER** connect the transceiver to an AC outlet. This may pose a fire hazard or result in an electric shock.

⚠ **WARNING! NEVER** connect the transceiver to a power source of more than 16 V DC such as a 24 V DC. This could cause a fire or damage the transceiver.

⚠ **WARNING! NEVER** reverse the DC power cable polarity when connecting to a power source. This could damage the transceiver.

⚠ **WARNING! NEVER** operate the transceiver during a lightning storm. It may result in an electric shock, cause a fire or damage the transceiver. Always disconnect the power source and antenna before a storm.

⚠ **WARNING! NEVER** cut the DC power cable between the DC plug and fuse holder. If an incorrect connection is made after cutting, the transceiver may be damaged.

⚠ **WARNING! NEVER** let metal, wire or other objects touch any internal part or connectors on the rear panel of the transceiver. This may result in an electric shock or this could cause a fire or damage the transceiver.

⚠ **WARNING! NEVER** operate or touch the transceiver with wet hands. This may result in an electric shock or may damage the transceiver.

⚠ **WARNING!** Immediately turn OFF the transceiver power and remove the power cable if it emits an abnormal odor, sound or smoke. Contact your Icom dealer or distributor for advice.

CAUTION: NEVER expose the transceiver to rain, snow or any liquids.

CAUTION: NEVER change the internal settings of the transceiver. This may reduce transceiver performance and/or damage to the transceiver.

PRECAUTIONS (Continued)

CAUTION: NEVER place the transceiver where normal operation of the vehicle may be hindered or where it could cause bodily injury.

DO NOT operate the transceiver near unshielded electrical blasting caps or in an explosive atmosphere.

DO NOT push the PTT when not actually desiring to transmit.

DO NOT use harsh solvents such as benzine or alcohol to clean the transceiver, as they will damage the transceiver's surfaces. If the transceiver becomes dusty or dirty, wipe it clean with a soft, dry cloth.

DO NOT use or place the transceiver in areas with temperatures below -10°C ($+14^{\circ}\text{F}$) or above $+60^{\circ}\text{C}$ ($+140^{\circ}\text{F}$). Be aware that temperatures on a vehicle's dashboard can exceed $+80^{\circ}\text{C}$ ($+176^{\circ}\text{F}$) in direct sunlight, resulting in permanent damage to the transceiver if left there for extended periods.

DO NOT place the transceiver in excessively dusty environments or in direct sunlight.

DO NOT place the transceiver against walls or putting anything on top of the transceiver. This will obstruct heat dissipation.

Place the transceiver in a secure place to avoid inadvertent use by children.

During mobile operation, **NEVER** place the transceiver where air bag deployment may be obstructed.

During mobile operation, **DO NOT** place the transceiver where hot or cold air blows directly onto it.

During mobile operation, **DO NOT** operate the transceiver without running the vehicle's engine. When the transceiver's power is ON and your vehicle's engine is OFF, the vehicle's battery will soon become exhausted.

Make sure the transceiver power is OFF before starting the vehicle engine. This will avoid possible damage to the transceiver by ignition voltage spikes.

During maritime mobile operation, keep the transceiver and microphone as far away as possible from the magnetic navigation compass to prevent erroneous indications.

BE CAREFUL! The rear panel will become hot when operating the transceiver continuously for long periods of time.

Use Icom microphones only (supplied or optional). Other manufacturer's microphones have different pin assignments, and may damage the transceiver.

Icom, Icom Inc. and the Icom logo are registered trademarks of Icom Incorporated (Japan) in Japan, the United States, the United Kingdom, Germany, France, Spain, Russia, Australia, New Zealand, and/or other countries.

The Bluetooth word mark and logos are registered trademarks owned by Bluetooth SIG, Inc. and any use of such marks by Icom inc. is under license.

All other products or brands are registered trademarks or trademarks of their respective holders.

TABLE OF CONTENTS

EXPLICIT DEFINITIONS.....	i	■ Writing into a Memory or Call channel..	30	9 INSTALLATION AND CONNECTIONS .	63
IMPORTANT.....	i	■ Setting a Memory bank	32	■ Connecting to a DC power supply	64
SUPPLIED ACCESSORIES.....	i	■ Entering a Memory or Bank name ...	34	■ Installing the controller	64
PRECAUTIONS.....	ii	■ Clearing a Memory channel	35	■ Installing in a vehicle	66
1 PANEL DESCRIPTION.....	1	5 SCAN OPERATION.....	36	■ Installing an antenna	67
■ Controller — Front panel	1	■ About the scan function.....	36	■ Connecting to a battery	68
■ Controller — Display.....	2	■ Entering scan edges.....	38	10 OPTIONS.....	70
■ Main unit.....	5	■ VFO mode scan.....	41	11 Bluetooth® OPERATION	71
■ About the HM-207 microphone	6	■ Setting and clearing the skip frequencies..	42	■ Operating Bluetooth®.....	71
2 MENU MODE.....	9	■ Memory scan.....	43	■ Electromagnetic Interference.....	71
■ MENU mode construction	9	■ Setting and clearing skip channels... 44		■ Installing the UT-133/UT-133A.....	72
■ Selecting the MENU item	11	■ Setting the temporary skip function.. 44		■ Pairing with a headset.....	73
■ Setting items.....	12	6 PRIORITY WATCH	45	■ VOX function.....	74
■ MENU items	18	■ Priority watch.....	45	■ Other headset settings	75
3 BASIC OPERATION.....	23	■ VFO and a Priority channel	46	■ The maximum number of paired headsets..	77
■ Selecting the MAIN band.....	23	■ VFO and a Memory/Bank scan	47	■ Disconnecting from a headset.....	77
■ Selecting the Mode.....	23	7 REPEATER AND DUPLEX OPERATIONS. 48		■ Deleting a headset from the pairing list..	77
■ Selecting the operating band.....	24	■ Repeater operation.....	48	■ Resetting the installed Bluetooth® unit .	78
■ Setting a frequency	24	■ Duplex operation	50	12 SPECIFICATIONS	79
■ Setting audio volume and squelch level .	25	■ Off band indication	51	■ Resetting	81
■ Lock function	25	■ Auto repeater function	52	13 MAINTENANCE	81
■ Transmitting	26	8 OTHER FUNCTIONS.....	53	■ Power protect function	82
■ Selecting the operating mode.....	26	■ Home Channel Beep function	53	■ Spurious signals.....	82
■ Audio mute function.....	27	■ Using the DTMF Memory	54	■ Fuse replacement.....	82
■ Monitor function.....	27	■ Transmitting DTMF code	55	■ Troubleshooting	83
■ Setting the microphone gain level	27	■ Tone Squelch function	56	14 INFORMATION	85
4 MEMORY OPERATION.....	28	■ Weather channel operation	60	COUNTRY CODE LIST	85
■ General description	28	■ Cloning function.....	61	FCC INFORMATION.....	85
■ Selecting a Memory or Call channel. 29		■ Connecting the controller to the main unit..	63	INDEX.....	85
		■ Connecting a microphone	63		

Controller — Front panel

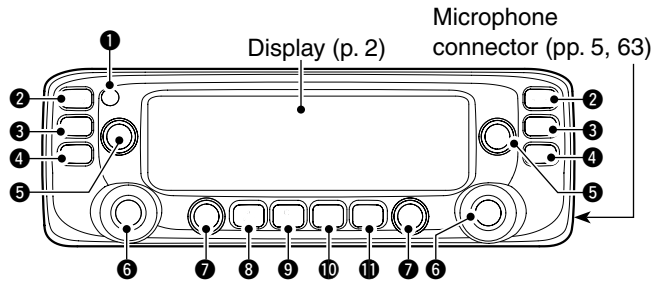

For your reference:

The key-touch beep tones on the left band are different than the tones on the right band. The different tones will let you know which band you are operating on.

❶ POWER KEY [⏻] [⏷]

- ➔ Hold down for 1 second to turn power ON or OFF.
- ➔ Push to mute the audio. (p. 27)

❷ MAIN•BAND KEY [MAIN BAND]

Push to select the MAIN band. (p. 23)

In the VFO mode

Hold down for 1 second to enter the Operating band select mode. (p. 24)

In the Memory mode

Hold down for 1 second to enter the Memory bank select mode. (p. 33)

❸ VFO/MHz TUNING•SCAN KEY [V/MHz SCAN]

- ➔ Push to select the VFO mode.
- ➔ In the VFO mode, push to select 1 MHz tuning. (p. 24)
- ➔ Hold down for 1 second to display the scan type setting screen. (pp. 41, 43)

❹ MEMORY•CALL KEY [MR CALL]

- ➔ In the VFO mode, push to select the Memory mode. (p. 23)
 - ➔ In the Memory mode, push to select the Weather channel mode.* (p. 23)
- *Weather channels are selectable in only the USA version.
- ➔ Hold down for 1 second to select the Call channel mode. (p. 23)

❺ VOLUME CONTROL (p. 23)

❻ TUNING DIAL [DIAL]

In the VFO mode

Rotate to select the operating frequency. (pp. 24, 25)

In the Memory mode

Rotate to select a Memory channel. (p. 29)

While scanning

Rotate to change the scanning direction. (p. 37)

In the MENU mode

Rotate to select a desired option or value. (p. 11)

❼ SQUELCH CONTROL (p. 25)

Rotate to adjust the squelch level.

8 MONITOR•DUPLEX KEY [DUP MONI]

- ➔ Push to turn the Monitor function ON and OFF. (p. 27)
- ➔ Hold down for 1 second to display the duplex direction setting screen. (p. 50)

9 OUTPUT POWER•DTMF KEY [LOW DTMF]

- ➔ Push to select the transmit output power level. (p. 26)
- ➔ Hold down for 1 second to enter the DTMF Menu mode. (p. 54)

10 MEMORY WRITE KEY [MW]

In the VFO mode

- ➔ Push to display the Memory write screen. (p. 30)
- ➔ Hold down for 1 second to store the operating frequency into a blank Memory channel. (p. 30)

In the Memory mode

- ➔ Push to display the Memory entry screen. (p. 31)

11 MENU LOCK KEY [MENU \leftrightarrow O]

- ➔ Push to enter the MENU mode.
- ➔ Hold down for 1 second to turn the Lock function ON or OFF.

Controller — Display

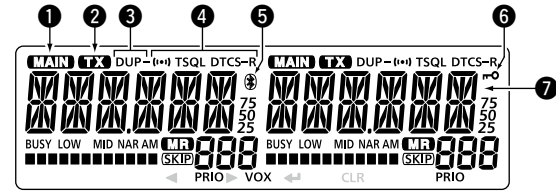

1 MAIN ICON

- Displayed on the MAIN band. (p. 23)
 - You can transmit on only the MAIN band.
 - The MENU mode settings are for the MAIN band.

2 TX ICON (p. 26)

- Displayed while transmitting.

3 DUPLEX ICON (p. 50)

- Displayed while in the duplex mode.

4 TONE ICONS (p. 56)

5 Bluetooth® ICON (p. 74)

- Displayed when you make a Bluetooth® connection between your transceiver* and a Bluetooth® headset.
- * Requires an optional UT-133/A Bluetooth® UNIT installed.

6 KEY LOCK ICON (p. 25)

- Displayed when the Lock function is ON.

7 FREQUENCY READOUT (pp. 9, 24)

- Displays the operating frequency, MENU item, and so on.

1 PANEL DESCRIPTION

■ Controller — Display (Continued)

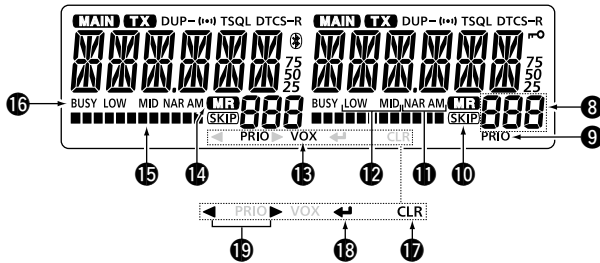

- 8 MEMORY CHANNEL NUMBER** (p. 29)
Displays the selected Memory channel, Memory Bank, Call channel, or Menu item.
- 9 PRIORITY ICON** (p. 46)
Displayed when Priority Watch is turned ON.
- 10 SKIP ICON** (p. 42)
Appears when the displayed Memory channel is specified as a skip channel.
- 11 MODE ICON** (p. 26)
Displays the operating mode.
- 12 POWER ICON** (p. 26)
Displays the output power level.
 - “LOW” is displayed when you select low power.
 - “MID” is displayed when you select mid power.
 - No icon is displayed when you select high power.

- 13 VOX ICON** (p. 75)
Displayed when the transceiver is connected to the optional VS-3 Bluetooth® HEADSET, and the VOX function is ON.
- 14 MEMORY MODE ICON** (p. 29)
Displayed while in the Memory mode.
- 15 S/R/F METER**
 - ➔ Displays the relative signal strength of the receive signal.
 - ➔ Displays the output power level of the transmit signal. (p. 26)
- 16 BUSY ICON**
 - ➔ Displayed while a signal is being received, or the squelch is open.
 - ➔ Blinks while the Monitor function is activated. (p. 27)

/// The following key icons are displayed in the MENU mode or Memory write screen, and you can push a key that is located below the icon.

17 CLEAR KEY [CLR]

In the MENU mode

Push to return to the previous screen. (p. 9)

While entering text

- ➔ Push to delete the selected character or number. (p. 34)
- ➔ Hold down for 1 second to delete the selected character or number, and all characters that are located to the right of the cursor. (p. 54)

18 ENTER KEY [↵]

Push to go to the next tree level or to set the option or value in the MENU mode. (pp. 11, 30)

19 LEFT/RIGHT KEYS [◀]/[▶]

In the MENU mode (p. 11)

[◀]: Push to go back the previous tree level.

[▶]: Push to go to the next tree level.

While entering text (p. 34)

[◀]: Push to move the cursor left.

[▶]: Push to move the cursor right.

1 PANEL DESCRIPTION

■ Main unit

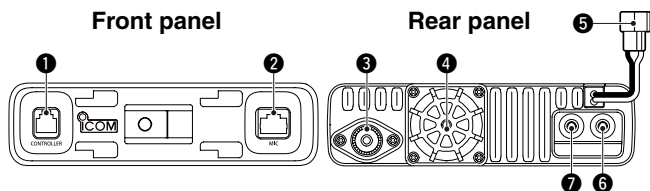

- 1 CONTROLLER CONNECTOR [CONTROLLER]** (p. 63)
Connects to the Controller using the supplied control cable.
- 2 MICROPHONE CONNECTOR [MIC]**
Plug in the supplied HM-207 microphone or the optional HM-154 microphone.
- 3 ANTENNA CONNECTOR** (p. 67)
Connect a 50 Ω impedance antenna with a PL-259 connector. The transceiver has a built-in duplexer, so you can use a 144 and 430 MHz dual-band antenna without needing an external duplexer. See page 67 for details of the internal duplexer.
- 4 COOLING FAN**
The cooling fan for heat dissipation. You can select the Fan control option in EXMENU, to automatically start rotating when you begin transmitting, or continuously rotate from power ON. (p. 14)
- 5 DC POWER SOCKET [DC 13.8V]**
Connect a 13.8 V DC power source through the supplied DC power cable.

6 EXTERNAL SPEAKER JACK 2 [SP2]

7 EXTERNAL SPEAKER JACK 1 [SP1]

Connect an 8 ohm external speaker.

- See the following list for the speaker connection and audio output details.

Ext. speaker connection status	Audio output		
	External speaker		Internal speaker
	SP-1	SP-2	
SP-1 and SP-2	Left band	Right band	–
SP-1 only	Both bands	–	–
SP-2 only	–	Right band	Left band

◇ Microphone connector information

 Front panel view	1	8 V	+8 V DC output Maximum 10 mA
	2	MIC U/D	Frequency Up/Down UP: Ground DN: Ground through 470 Ω
	3	M8V SW	HM-207 connection Grounds when the HM-207 is connected.
	4	PTT	PTT input Ground for transmission
	5	MIC E	Microphone ground
	6	MIC	Microphone input
	7	GND	PTT ground
	8	DATA IN	Inputs HM-207 data when the HM-207 is connected.

■ About the HM-207 microphone

With the HM-207, you can input numbers for frequency or Memory channel settings, and adjust the audio volume and squelch level.

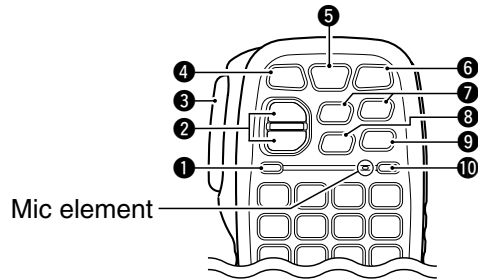

- 1 LED 1**
Lights red while transmitting by pushing [PTT].
- 2 [▲]/[▼] (UP/DOWN) KEYS**
 - ➔ Push to change the operating frequency or Memory channel.
 - ➔ Hold down to continuously change the frequency or Memory channel.
- 3 [PTT] SWITCH**
Hold down to transmit, release to receive.
- 4 [VFO/MR] KEY**
 - ➔ Push to toggle between the VFO and Memory modes.
 - ➔ Hold down for 1 second to turn the Lock function ON or OFF. (p. 25)

- 5 [HOME CALL] KEY**
 - ➔ Push to select the Home channel.
 - ➔ Hold down for 1 second to turn the Call channel mode ON or OFF.

- 6 [MAIN DUAL] KEY**
Push to set the MAIN band to either the right band or the left band.

- 7 [F-1] KEY**
Push to activate the preset function of the [F-1] key.
(Default: During RX/Standby: [BND.BNK]
During TX: [T-CALL])

- [F-2] KEY**
Push to activate the preset function of the [F-2] key.
(Default: During RX/Standby: [MONI],
During TX: [---])

▨ You can assign a desired function in the MENU mode.
▨ (p. 14) See page 8 for details of the key functions.

- 8 [CLR] KEY**
In the MENU mode, push to exit the MENU mode.
- 9 [ENT] KEY**
After entering a VFO frequency or Memory channel number, push to set.

- 10 LED 2**
Lights green when transceiver's power is ON.

1 PANEL DESCRIPTION

■ Microphone (HM-207) (Continued)

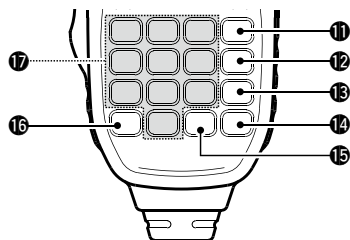

11 [VOL▲ A] KEY

- ➔ Push to increase the audio output level.
- ➔ Push to input DTMF code 'A.'

12 [VOL▼ B] KEY

- ➔ Push to decrease the audio output level.
- ➔ Push to input DTMF code 'B.'

13 [SQL▲ C] KEY

- ➔ Push to increase the squelch level.
- ➔ Push to input DTMF code 'C.'

14 [SQL▼ D] KEY

- ➔ Push to decrease the squelch level.
- ➔ Push to input DTMF code 'D.'

15 [# CE] KEY

- ➔ In the frequency entry screen, push to delete a number.
- ➔ Push to input DTMF code '#.'
 - 'F' stands for '#' on the display.

16 [* .] KEY

- ➔ Push to input a '.' (decimal point) when entering a frequency.
- ➔ Push to input DTMF code '*.'
 - "E" stands for "*" on the display.

17 [0] to [9] KEYS

- ➔ Push to input a frequency, or DTMF codes '0' through '9.'

◇ Setting frequency and Memory channel

[Example for setting the frequency]

First, push [VFO/MR 

To enter 435.680 MHz:

- ➔ Push [4], [3], [5], [6], [8], then [0].

To change 435.680 MHz to 435.540 MHz:

- ➔ Push [•], [5], [4], then [0].

To enter 433.000 MHz:

- ➔ Push [4], [3], [3], then [ENT].

[Example for setting the Memory channel]

To select the Memory channel '5':

- 1 First, push [VFO/MR - 2 Push [5] then [ENT].

[Example for setting the Call channel]

To select a Call channel:

- 1 First, hold down [HOME CALL] for 1 second to select the Call channel mode.
- 2 When C0 is selected, push [▲] to select C1.
When C1 is selected, push [▼] to select C0.

The following functions can be set to [F-1] and [F-2] to use during receive or in stand-by, or during transmit. (p. 14)

During RX/Standby:

Function	Description
---	No function
MONI ([F2] key: Default)	Push to open or close the squelch.
MR000	In the Memory mode, push to select Memory channel 000.
MR001	In the Memory mode, push to select Memory channel 001.
BND.BNK ([F1] key: Default)	In the VFO mode, push to select an operating band. In the Memory mode, push to select Bank A to J, or OFF. • Only the programmed bank appears.
SCAN	Push to start or stop a scan.
T-SKIP	Push to set the frequency to be skipped during scanning. The selected frequencies are temporarily skipped for faster scanning.
MODE	Push to change the operating mode.
LOW	Push to change the transmit power level.
DUP	Push to turn the Duplex mode ON or OFF, and the shift direction to DUP+ or DUP-.
PRIO	Push to turn the Priority watch ON or OFF.
TONE	Push to toggle between tone types.

Function	Description
MW	In the VFO mode, hold down for 1 second to save the frequency displayed in the MAIN band into a Memory channel. • The frequency is automatically saved in a blank channel.
MUTE	Push to turn the Mute function ON or OFF.
DTMFTX	Push to display the DTMF code direct entry mode screen.
T-CALL	Push to transmit a 1750 Hz tone.

During TX:

Function	Description
---	No function
([F2] key: Default)	
LOW	Push to change the transmit power level.
T-CALL ([F1] key: Default)	Push to transmit a 1750 Hz tone.

2

MENU MODE

The MENU mode is used to program infrequently changed values or function settings.

• The MENU mode items are for the MAIN band.

■ MENU mode construction

The MENU mode is constructed in a tree structure.

You can go to the next tree level, or go back a level by pushing [CLR]D, [↵]D, [◀]D or [▶]D. (p. 11)

MENU	
TONE	OFF/TONE/TSQL(●●)/TSQL/DTC S(●●)/DTCS/TSQ-L-R/DTCS-R/DTC.OFF/TON.DTC/DTCS.TSQ/TON.TSQ
OFFSET	0.000 ~ 59.995
R TONE	67.0 ~ 254.1
C TONE	67.0 ~ 254.1
CODE	023 ~ 754
DTCS-P	BOTH N/TN-RR/TR-RN/BOTH R
TS	5.0 ~ 50.0/AUTO
LIGHT	1 ~ 4
PRIO	OFF/ON/BELL
PAUSE	2 ~ 20SEC/HOLD
RESUME	0SEC/1 ~ 5SEC/HOLD
WX-ALT	OFF/ON
MODE	FM/FM-N, AM/AM-N
HOMECH	SET.FRQ, SET CH/CLEAR
EXMENU	EXMENU construction is shown to the right.

For your reference:

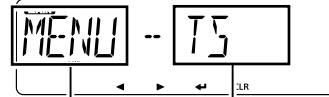

The MENU item is displayed on the left side.
The item's option or value is displayed on the right side.

EXMENU		
MOD.TS		
MODE	FM/FM-N/AM/AM-N	
TS	5.0 ~ 50.0/AUTO	
DUPT		
TONE	OFF/TONE/TSQL(●●)/TSQL/DTC S(●●)/DTCS/TSQ-L-R/DTCS-R/DTC.OFF/TON.DTC/DTCS.TSQ/TON.TSQ	
OFFSET	0.000 ~ 59.995	
R TONE	67.0 ~ 254.1	
C TONE	67.0 ~ 254.1	
TBURST	OFF/ON	
CODE	023 ~ 754	
DTCS-P	BOTH N/TN-RR/TR-RN/BOTH R	
SCAN		
PRIO	OFF/ON/BELL	
PAUSE	2 ~ 20SEC/HOLD	
RESUME	0SEC/1 ~ 5SEC/HOLD	
TEMP	5MIN/10MIN/15MIN	
WX-ALT	OFF/ON	
P-SKIP	OFF/ON	
B-LINK	BANK-A ~ J	OFF/ON
P-EDGE	PROG00 ~ 24	NAME/FREQ L/FREQ H/TS/MODE/WRITE
P-LINK	PLINK0 ~ 9	LINK/NAME/ADD/CLEAR

EXMENU (Continued)

FUNC

SQLTYP	OFF/S SQL/ATT
SQL-DL	SHORT/LONG
FAN	SLOW/MID/FAST/AUTO
DIAL S	OFF/ON
AUTORP*	OFF/ON (KOR version) OFF/DUP/DUP.TON (USA version)
RMTMIC	RX/TX
UDMIC	RX/TX
PTT	PUSH/HOLD
PTT LK	OFF/ON
LK OUT	OFF/ON
TOT	OFF/1 ~ 30MIN
ACTIVE	SINGLE/ALL/HAM
MIC G	1 ~ 4
AP OFF	OFF/30 ~ 120MIN
CI-V	
CIVADR	01 ~ DF
CIVBAU	4800 ~ 19200/AUTO
CIVTRN	OFF/ON
IF-EXC	OFF/ON

DISP

LIGHT	1 ~ 4
AT-DIM	OFF/AT-OFF/AT-1 ~ 3
DIM TM	5SEC/10SEC
CONT	1 ~ 10
OPN.MSG	OFF/ON
NAME	OFF/ON
AIR*	CH ID/FREQ

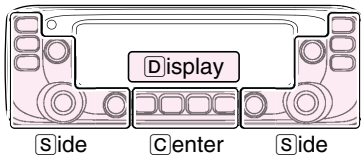

The [C], [S], or [D] in the instructions indicate the area of the controller.

- [C]: Center
- [S]: Side
- [D]: Display

SOUNDS

BEEPLV	0 ~ 9
KEY B	OFF/ON
HOME B	OFF/ON
EDGE B	OFF/ON
STOP B	OFF/ON
SUBMUT	OFF/MUTE/BEEP/MUT.BP

HOMECH

SET.FRQ SET CH/CLEAR

BT SET

BT	OFF/ON
AT CON	OFF/ON

CONNEC /DISCON PAIR

CONNEC /DISCON PAIR

HS SET

AF OUT	HS/HS+SP
HSFUNC	NORMAL/MIC/P-AMAN /P-ACON
VOX	VOX OFF/ON
VOX LV	VOX LV OFF/1 ~ 10
VOX.DLY	VOX.DLY 0.5 ~ 3.0
VOX.TOT	VOX.TOT OFF/1 ~ 15MIN
ICOMHS	PoSAVE OFF/ON
PTT	PTT PUSH/HOLD
PTT B	PTT B OFF/ON
CUST B	CUST B OFF/ON
CUST K	CUST K PLAY/FWD/RWD

INITBT

INITBT	YES/NO
--------	--------

OTHERS

INFO	VOLT/VER
CLONE	CLONE NO/YES
MASTER	MASTER NO/YES
PART	PART NO/YES
ALL	ALL NO/YES
RESET	

* This item may not be displayed, depending on the transceiver version.

2 MENU MODE

■ Selecting the MENU item

In addition to this page, see pages 12 through 22 for details.

For your reference:

The MENU system is constructed in a tree structure. You can go to the next tree level, or go back a level, depending on the selected item.

Example: Set the tuning step

- ① Push [MAIN BAND]**[S]** of the band that the tuning step is set.
 - Selects the Main band.
- ② Push [MENU] **[C]**.
 - Enters the MENU mode.
- ③ Rotate [DIAL]**[S]** to select the “MENU-TS” (Tuning step) item.

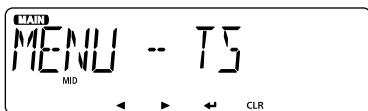

- ④ Push [**↵**]**[D]**.
 - Goes to the next tree level.

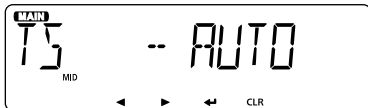

- Pushing [**▶**]**[D]** also goes to the next tree level.

- ⑤ Rotate [DIAL]**[S]** to select the desired value.

Selectable values (kHz):

5.0, 6.25, 8.33*, 10.0, 12.5, 15.0, 20.0, 25.0, 30.0, 50.0, or AUTO*.

* Appears only when the AIR band is selected.

- ⑥ Push [**↵**]**[D]**.
 - Sets the selected value, and goes back to the previous tree level.
 - Pushing [**◀**]**[D]** also goes back to the previous tree level.
- ⑦ Push [MAIN BAND]**[S]**.
 - Exits the MENU mode.
 - Pushing [V/MHz SCAN]**[S]** or [MR CALL]**[S]** also exits the MENU mode.

To return to the default setting:

Hold down [MR CALL] after doing step ④.

/// See the Icom website for details of the EXMENU mode items.

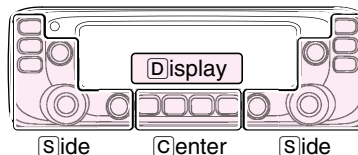

The **[C]**, **[S]**, or **[D]** in the instructions indicate the area of the controller.

[C]: Center

[S]: Side

[D]: Display

■ Setting items

◇ MENU mode

See pages 18 to 22 for details of each MENU mode item's options and their default values.

See page 11 for details of the operation.

Tone Sets a channel tone type.	MENU - TONE
Frequency offset Sets the frequency offset for duplex (repeater) operation.	MENU - OFFSET
Repeater tone Sets a tone frequency used to access repeaters.	MENU - R TONE
TSQL frequency Sets a tone frequency for the Tone squelch function used in the FM mode.	MENU - C TONE
DTCS code Sets a DTCS (both encoder/decoder) code for DTCS squelch function used in the FM mode.	MENU - CODE
DTCS polarity Sets the DTCS polarity for the DTCS squelch function.	MENU - DTCS-P
Tuning step Sets the tuning step to change the frequency in the selected step when rotating [DIAL][S].	MENU - TS
Backlight Sets the backlight brightness level.	MENU - LIGHT
Priority scan Starts or stops the Priority scan.	MENU - PRIO

Pause timer Sets the scan pause time. When receiving signals, the scan pauses according to the scan pause timer.	MENU - PAUSE
Resume timer Sets the scan resume time from a pause after the received signal disappears.	MENU - RESUME
Weather alert Sets to sound a beep when a weather alert signal is detected on a preset weather channel. (Only for the USA version's transceiver)	MENU - WX-ALT
Operating mode Sets the operating mode.	MENU - MODE
Home channel Sets the often-used frequency as the Home channel in the VFO mode or Memory mode.	MENU - HOMECH
EXMENU mode Push [↵] or [▶] to enter the EXMENU mode.	MENU - EXMENU

◇ EXMENU mode

See the Icom website for details of the EXMENU mode items. See page 11 for details of the operation.

Mode and Tuning step items Sets the operating mode and the tuning step.	EXMEN- MOITS
Operating mode* Sets the operating mode.	MOITS- MODE
Tuning step* Sets the tuning step to change the frequency in the selected step when rotating [DIAL][S].	MOITS- TS

*You can set in the MENU mode.

2 MENU MODE

■ Setting items

◇ EXMENU mode (Continued)

See page 11 for details of the operation.

DUP/TONE items	EXMEN-- DUPT
----------------	--------------

Settings to access repeaters.

Tone*	DUPT -- TONE
--------------	--------------

Sets a channel tone type.

Frequency offset*	DUPT -- OFFSET
--------------------------	----------------

Sets the frequency offset for duplex (repeater) operation.

Repeater tone*	DUPT -- R TONE
-----------------------	----------------

Sets a tone frequency used to access repeaters.

TSQL frequency*	DUPT -- C TONE
------------------------	----------------

Sets a tone frequency for the Tone squelch function used in the FM mode.

Tone burst	DUPT -- TBURST
-------------------	----------------

Turns the Tone Burst function ON or OFF.

This function is used to suppress the squelch tail noise heard from the called transceiver's speaker.

DTCS code*	DUPT -- CODE
-------------------	--------------

Sets a DTCS (both encoder/decoder) code for DTCS squelch function used in the FM mode.

DTCS polarity*	DUPT -- DTCS--P
-----------------------	-----------------

Sets the DTCS polarity for the DTCS squelch function.

Scan items	EXMEN-- SCAN
------------	--------------

Set scan options.

Priority scan*	SCAN -- PRIO
-----------------------	--------------

Starts the Priority scan.

Pause timer*	SCAN -- PAUSE
---------------------	---------------

Selects the scan pause time. When receiving signals, the scan pauses according to the scan pause timer.

Resume timer*	SCAN -- RESUME
----------------------	----------------

Selects the scan resume time from a pause after the received signal disappears.

Temporary skip timer	SCAN -- TEMP
-----------------------------	--------------

Selects the Temporary Skip Time. When the time is set, specified frequencies are skipped for this period during a scan.

Weather alert*	SCAN -- WX-ALT
-----------------------	----------------

Sets to sound a beep when a weather alert signal is detected on a preset weather channel. (Only for the USA version's transceiver)

Program skip scan	SCAN -- P--SKIP
--------------------------	-----------------

Turns the Program Skip Scan function ON or OFF for a VFO mode scan.

Bank link	SCAN -- B-LINK
------------------	----------------

Selects banks to be scanned during a Bank link scan.

Program scan edge	SCAN -- P--EDGE
--------------------------	-----------------

Sets the frequency ranges for the Program scan.

Program scan	PEGE-- PROG00
---------------------	---------------

Displays 25 Program scans.

Name	POD -- NAME
-------------	-------------

Enters a name into each Program scan.

Frequency low	POD -- FREQ L
----------------------	---------------

Sets the lower edge frequency for each Program scan.

Frequency high	POD -- FREQ H
-----------------------	---------------

Sets the higher edge frequency for each Program scan.

* You can set in the MENU mode.

Tuning step	POD -- TS
Sets the tuning step for each Program scan.	
Operating mode	POD -- MODE
Sets the operating mode for each Program scan.	
Program link	SCAN -- P-LINK
Sets the link function for the Program scan.	
Program scan link channels	PLINK-- PLINK0
Displays 10 Program scan link memories.	
Link	LINK0-- LINK
Displays the Program scans that are linked during the Program link scan.	
Name	LINK0-- NAME
Enters a name into each Program scan link memory.	
Add	LINK0-- ADD
Adds the Program scan that is linked during the Program link scan.	
Clear	LINK0-- CLEAR
Deletes the Program scan that is linked during the Program link scan.	
Function items EXMEN-- FUNC	
Sets various function's options.	
Squelch/ATT select	FUNC -- SQLTYP
Sets to use the S-Meter Squelch or the Attenuator function for the [SQL] control.	
Squelch delay	FUNC -- SQL--DL
Set the squelch delay to prevent repeated opening and closing of the squelch when receiving the same signal.	

Fan control	FUNC -- FAN
Sets the cooling fan control operation.	
Dial speed-up	FUNC -- DIAL S
Sets to automatically increase the tuning dial speed when rapidly rotating [DIAL] [S].	
Auto repeater	FUNC -- AUTORP
Sets the Auto Repeater function. This item appears only in the Korean and USA version's transceivers.	
Remote MIC key	FUNC -- RMTMIC
Selects the key function for [F-1] or [F-2] on the supplied HM-207.	
During RX/Standby	RMTMIC-- RX
Selects the key function to be used while receiving or in the standby mode.	
During TX	RMTMIC-- TX
Selects the key function to be used while transmitting.	
Up/Down MIC key	FUNC -- UDMIC
Selects the key function for [UP] or [DN] on the optional HM-154.	
During RX/Standby	UDMIC-- RX
Selects the key function to be used while receiving or in the standby mode.	
During TX	UDMIC-- TX
Selects the key function to be used while transmitting.	
One-Touch PTT	FUNC -- PTT
Sets the One-Touch PTT function to toggle between transmission and reception by pushing [PTT].	

2 MENU MODE

■ Setting items

◇ EXMENU mode

See page 11 for details of the operation.

Function items (Continued)	EXMEN- FUNC
PTT lock Turns the PTT Lock function ON or OFF. To prevent accidental transmissions, this function disables [PTT].	FUNC - PTT LK
Busy lockout Turns the Busy Lockout function ON or OFF. This function inhibits transmission while receiving a signal, or when the squelch is open.	FUNC - LK OUT
Time-out timer Sets the Time-out timer to prevent an accidental prolonged transmission.	FUNC - TOT
Active band Allows continuous frequency selection across all bands by rotating [DIAL].	FUNC - ACTIVE
MIC gain Sets the microphone sensitivity to suit your preference.	FUNC - MIC G
Auto power OFF Sets to automatically turn OFF the transceiver after a preset time period of inactivity.	FUNC - AP OFF
CI-V See the Icom website for details of the CI-V command.	FUNC - CI-V
CI-V address Sets the transceiver's unique CI-V hexadecimal address code.	CI-V - CIVADR
CI-V baud rate Sets the CI-V data transfer speed.	CI-V - CIVBAU

CI-V transceive Turns the CI-V Transceive function ON or OFF.	CI-V - CIVTRN
IF exchange Sets to exchange the Intermediate Frequency between left and right bands to avoid interference.	FUNC - IF-EXC

Display items	EXMEN- DISP
Sets the Display options.	
Backlight* Sets the backlight brightness level.	DISP - LIGHT
Auto dimmer Sets the Auto dimmer function, and the dimmer level.	DISP - AT-DIM
Auto dimmer timer Sets the auto dimmer time period.	DISP - DIM TM
LCD contrast Sets the contrast level of the LCD.	DISP - CONT
Opening message Sets whether or not to display "ICOM" and the power source voltage at power ON.	DISP - OPNMSG
Memory name Sets to display either the operating frequency or the channel name in the Memory mode.	DISP - NAME
AIR band display Sets the AIR band display type between Frequency and ID. This item may not be displayed, depending on the transceiver version.	DISP - AIR

*You can set in the MENU mode.

Sound items EXMEN-- SOUNDS

Sets the Sound options.

Beep level SOUND-- BEEPLV

Sets the beep output level.

Key-touch beep SOUND-- KEY B

Sets to sound a beep when you push a key.

- The beep tones are different between on the left band and the right band.

Home channel beep SOUND-- HOME B

Sets to sound a beep when you select the Home channel.

Band edge beep SOUND-- EDGE B

Sets to sound a beep when you tune into or out of the AIR, VHF and UHF band's frequency range by rotating [DIAL].

Scan stop beep SOUND-- STOP B

Sets to sound a beep when a scan stops by receiving a signal.

Sub band mute SOUND-- SUBMUT

Selects to mute the SUB band audio signal while receiving on the MAIN band, and/or sound a beep when a signal disappears on the SUB band.

Home channel items* EXMEN-- HOMECH

Sets the often-used frequency as the Home channel in the VFO mode or Memory mode.

Setting HOME -- SETFRQ
HOME -- SET CH

Sets a displayed frequency (and operating mode for AIR band) as a Home channel.

Clear HOME -- CLEAR

Deletes the current Home channel.

This item does not appear when no Home channel is set.

Bluetooth® items EXMEN-- BT SET

Sets the Bluetooth® options when you use a Bluetooth® headset.

Bluetooth® BTSET-- BT

Turns the Bluetooth® function ON or OFF.

Auto Connect BTSET-- AT CON

Sets to automatically connect to the paired Bluetooth® headset when the headset power is ON.

Connection BTSET-- CONNEC

Displays the paired Bluetooth® headsets.

You can manually connect to a selected headset.

Disconnection BTSET-- DISCON

Disconnects from the connected Bluetooth® headset without cancelling the pairing.

Paring BTSET-- PAIR

Makes the transceiver to enter the pairing mode to pair with a Bluetooth® headset.

Headset Set BTSET-- HS SET

AF output HSSET-- AF OUT

Selects the AF output option for when you use the Bluetooth® headset.

Headset function setting HSSET-- HSFUNC

Selects a desired PTT and microphone combination when both a Bluetooth® headset and the transceiver microphone are used.

2 MENU MODE

■ Setting items

◇ EXMENU mode

See page 11 for details of the operation.

Bluetooth® items (Continued)	EXMEN-- BT SET
VOX	HSSET-- VOX
VOX	VOX -- VOX
Sets the VOX (Voice Operated Transmission) function for when you use the Bluetooth® headset.	
VOX level	VOX -- VOX LV
Set the VOX gain level. Higher values make the VOX function more sensitive to your voice.	
VOX delay	VOX -- VOX DLY
Sets the VOX Delay time for the transmitter stays ON after you stop speaking before the VOX switches to receive.	
VOX Time-out timer	VOX -- VOX TOT
Sets the VOX Time-Out Timer to prevent an accidental prolonged transmission.	
Icom headset	HSSET-- ICOMHS
Sets to use the optional Bluetooth® headset (VS-3).	
Power save	ICOMH-- POWSAVE
Sets the Power save function to prolong the headset battery.	
One-Touch PTT	ICOMH-- PTT
Sets the One-Touch PTT function to toggle between transmission and reception by pushing [PTT].	
PTT beep	ICOMH-- PTT B
Sets to sound a beep when you push [PTT].	
Custom key beep	ICOMH-- CUST B
Sets to sound a beep when you push the custom key ([PLAY]/[FWD]/[RWD]).	

Custom key	ICOMH-- CUST K
Sets the key function of the custom key ([PLAY]/[FWD]/[RWD]).	
Initialize Bluetooth® unit	BTSET-- INITBT
Selects to clear the pairing status and paired unit name.	

Other items	EXMEN-- OTHERS
Set other options.	
Information	OTHER-- INFO
Voltage	INFO -- VOLT
Displays the voltage of the external DC power source.	
Version	INFO -- VER
Displays the transceiver's firmware version number or the optional UT-133/A Bluetooth® unit version, if installed.	
Clone	OTHER-- CLONE
Clone mode	CLONE-- CLONE
Sets the transceiver as a sub transceiver to receive data from a Master transceiver.	
Clone master mode	CLONE-- MASTER
Sets the transceiver as a master transceiver to send data to a Sub transceiver.	
Reset	OTHER-- RESET
Partial reset	RESET-- PART
Returns all settings to their defaults, without clearing the memory contents.	
All reset	RESET-- ALL
Clears all programming and memories, and return all settings to their defaults.	

■ MENU items

See page 11 for details of the operation.

Tone MENU - TONE (Default: OFF)

Select a desired channel tone type.

- OFF: The function is OFF.
- TONE: The subaudible tone is superimposed on your normal signal.
 - Subaudible tone setting: "R TONE"
- TSQL ("t•") appears):
 - Enables the tone squelch with the pocket beep function.
- TSQL: Enables the tone squelch function.
 - When you transmit, the tone frequency is superimposed on your normal signal.
 - The tone squelch opens only when you receive a signal that includes a matching tone frequency. (Audio is heard)
 - Tone frequency setting: "C TONE"
- DTCS ("t•") appears):
 - Enables the DTCS squelch with the pocket beep function.
- DTCS: Enables the DTCS squelch function.
 - When you transmit, the DTCS code is superimposed on your normal signal.
 - The DTCS squelch opens only when you receive a signal that includes a matching DTCS code and polarity. (Audio is heard)
 - DTCS code setting: "CODE"
 - DTCS polarity setting: "DTCS-P"
- TSQL-R: Enables the reverse tone squelch function.
 - The tone squelch does not open only when you receive a signal that includes a matching tone frequency. (Audio is not heard)
 - You can mute a specified station's audio.
 - Tone frequency setting: "C TONE"
- DTCS-R: Enables the reverse DTCS squelch function.
 - The DTCS squelch does not open only when you receive a signal that includes a matching DTCS code and polarity. (Audio is not heard)
 - You can mute a specified station's audio.
 - DTCS code setting: "CODE"
 - DTCS polarity setting: "DTCS-P"
- DTC.OFF: When you transmit, the selected DTCS code is superimposed on your normal signal.
 - When you receive, the function is OFF.
 - DTCS code setting: "CODE"
 - DTCS polarity setting: "DTCS-P"
- TON.DTC: When you transmit, the selected subaudible tone is superimposed on your normal signal.
 - When you receive, the DTCS squelch opens only for a signal that includes a matching DTCS code and polarity. (Audio is heard).
 - Subaudible tone setting: "R TONE"
 - DTCS code setting: "CODE"
 - DTCS polarity setting: "DTCS-P"

2 MENU MODE

■ MENU items (Continued)

See page 11 for details of the operation.

- **DTC.TSQ:** When you transmit, the DTCS code is superimposed on your normal signal.
When you receive, the tone squelch opens only for a signal that includes a matching tone frequency. (Audio is heard)
 - DTCS code setting: "CODE"
 - DTCS polarity setting: "DTCS-P"
 - Tone frequency setting: "C TONE"
- **TON.TSQ:** When you transmit, the subaudible tone is superimposed on your normal signal.
When you receive, the tone squelch opens only for a signal that includes a matching tone frequency. (Audio is heard)
 - Subaudible tone setting: "R TONE"
 - Tone frequency setting: "C TONE"

Offset frequency *MENU -- OFFSET* (Default: 0.600.00*)

Set the frequency offset for duplex (repeater) operation to between 0 and 59.99500 MHz.

- The duplex shift direction (DUP-/DUP) is set in the duplex setting screen that is displayed when you hold down [MONI DUP]Ⓢ for 1 second in the VFO mode. (p. 50)

*The default value may differ, depending on the frequency band (selected as the Main band before entering the MENU mode) and the transceiver version.

Repeater Tone *MENU -- R TONE* (Default: 88.5)

Select a CTCSS tone frequency for repeater or other tone squelch access.

50 tone frequencies (67.0 ~ 254.1 Hz) are selectable.

TSQL Freq *MENU -- C TONE* (Default: 88.5)

Select a CTCSS tone frequency for the tone squelch or the Pocket beep function.

50 tone frequencies (67.0 ~ 254.1 Hz) are selectable.

• **Tone frequencies** (Unit: Hz)

67.0	85.4	107.2	136.5	165.5	186.2	210.7	254.1
69.3	88.5	110.9	141.3	167.9	189.9	218.1	
71.9	91.5	114.8	146.2	171.3	192.8	225.7	
74.4	94.8	118.8	151.4	173.8	196.6	229.1	
77.0	97.4	123.0	156.7	177.3	199.5	233.6	
79.7	100.0	127.3	159.8	179.9	203.5	241.8	
82.5	103.5	131.8	162.2	183.5	206.5	250.3	

DTCS Code MENU - CODE (Default: 023)

Select a DTCS (both encoder/decoder) code for the DTCS squelch.

A total of 104 codes (023 ~ 754) are selectable.

• **DTCS codes**

023	054	125	165	245	274	356	445	506	627	732
025	065	131	172	246	306	364	446	516	631	734
026	071	132	174	251	311	365	452	523	632	743
031	072	134	205	252	315	371	454	526	654	754
032	073	143	212	255	325	411	455	532	662	
036	074	145	223	261	331	412	462	546	664	
043	114	152	225	263	332	413	464	565	703	
047	115	155	226	265	343	423	465	606	712	
051	116	156	243	266	346	431	466	612	723	
053	122	162	244	271	351	432	503	624	731	

DTCS Polarity MENU - DTCS-P (Default: BOTH N)

Select the DTCS polarity to use for transmitting and receiving.

- BOTH N: TX and RX polarity are Normal.
- TN-RR: TX polarity is Normal, RX polarity is Reverse.
- TR-RN: TX polarity is Reverse, RX polarity is Normal.
- BOTH R: TX and RX polarity are Reverse.

Tuning step MENU - TS (Default: 5.0)

When you rotate [DIAL] in the VFO mode, the frequency changes in the selected tuning step.

The selected tuning step is also used for a VFO mode scan.

Tuning steps (kHz):

5.0, 6.25, 8.33*, 10.0, 12.5, 15.0, 20.0, 25.0, 30.0, 50.0, or AUTO*

*Appears only when the AIR band is selected.

- In the AIR band, you can select only “8.33,” “25.0” or “AUTO.” (Default: AUTO)
- The default settings may differ, depending on your transceiver version.

Backlight MENU - LIGHT (Default: 4)

Set the backlight brightness level to between 1 (Dark) and 4 (Bright).

Priority scan MENU - PRIO (Default: OFF)

Starts or stops the Priority scan.

- OFF: Stops the Priority scan.
- ON: Starts the Priority scan.
When a signal is received on the priority channel, the channel is automatically selected.
- BELL: Starts the Priority scan.
When a signal is received on the Priority channel, beeps sound, and the “(••)” icon blinks on the display.

2 MENU MODE

■ MENU items (Continued)

See page 11 for details of the operation.

Pause Timer *MENU - PAUSE* (Default: 10SEC)

Select the Scan Pause time.

- 2SEC to 20SEC: When a signal is received, the scan pauses for 2 to 20 seconds (set in 2 second steps).
- HOLD: The scan pauses on a received signal until the signal disappears.

Resume Timer *MENU - RESUME* (Default: 2SEC)

Select the Scan Resume time.

When a received signal disappears, the scan resumes according to this setting.

- 0SEC: The scan resumes immediately after the signal disappears.
- 1SEC to 5SEC: The scan resumes 1 to 5 seconds after the signal disappears.
- HOLD: The scan remains paused for the "Pause Timer" setting, even if the signal disappears.
 - Rotate [DIAL]Ⓢ to resume the scan.
 - The Resume Timer must be set shorter than the Pause Timer, otherwise this timer does not work properly.

Weather alert *MENU - WX-ALT* (Default: OFF)

(Appears only for the USA version transceivers.)

Turn the Weather Alert function ON or OFF.

A NOAA (National Oceanographic and Atmospheric Administration) broadcast station transmits a weather alert tone before any important weather information.

This function detects the weather alert tone on weather channels.

- OFF: The function is OFF.
- ON: Monitors the selected weather channel every 5 seconds.

Operating mode *MENU - MODE* (Default: FM)

The transceiver has a total of four operating modes, FM, FM-N, AM and AM-N.

Operating modes are determined by the modulation of the radio signals.

- In the 144 and 430 MHz bands, select FM or FM-N.
- In the AIR band (118.000 MHz to 136.99166 MHz), select AM or AM-N.

- ▨ • In the AIR band, the default mode is AM.
- ▨ • While in the FM-N mode, the TX modulation is automatically set to narrow (approximate 2.5 kHz)

Home channel HOME -- SETFRQ, HOME -- SET CH

When you set an often-used frequency as the Home channel in the transceiver's VFO or Memory mode, that frequency is selected in each mode by pushing [HOME CALL] on the supplied microphone.

- SET.FRQ: Set the selected VFO frequency as the Home channel frequency.
- SET CH: Set the selected Memory channel frequency as the Home channel.

Home channel Clear HOME -- CLEAR

Push [↵] [D] to delete the Home channel.

EXMENU mode MENU -- EXMENU

Enters the EXMENU mode.

See pages 12 to 17 for the items that you can set in the EXMENU mode.

See the Icom website for details of the EXMENU mode items.

■ Selecting the MAIN band

- ➔ Push [MAIN BAND] [S] on either the left or right band to set it as the MAIN band.

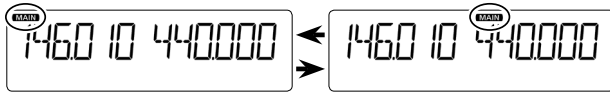

- “MAIN” appears on the MAIN band.
- You can transmit on only the MAIN band.

■ Selecting the Mode

- You can make the selection on either the left or right band, regardless of the MAIN band.

◇ VFO mode

You can use the VFO mode to set the operating frequency.

- ➔ Push [V/MHz SCAN] [S].
 - Selects the VFO mode.
 - Rotate [DIAL] [S] to select an operating frequency.

◇ Memory mode

You can use the Memory mode to operate on Memory channels.

- ➔ Push [MR CALL] [S].
 - Selects the Memory mode.
 - Rotate [DIAL] [S] to select a Memory channel.

◇ Call channel mode

You can use the Call channel mode to operate on the Call channels.

- ➔ Hold down [MR CALL] [S] for 1 second.
 - Selects the Call channel mode.
 - Rotate [DIAL] [S] to select a Call channel.

◇ Weather channel mode

(Selectable in only the U.S.A. version transceivers)

The Weather channel mode is used to hear weather broadcasts from the NOAA (National Oceanographic and Atmospheric Administration).

- ➔ In the Memory mode, push [MR CALL] [S].
 - Selects the Weather channel mode.
 - Rotate [DIAL] [S] to select a Weather channel.

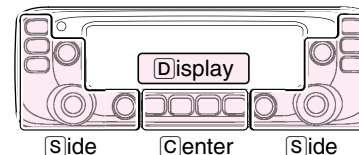

The [C], [S], or [D] in the instructions indicate the area of the controller.

- [C]: Center
- [S]: Side
- [D]: Display

■ Selecting the operating band

The transceiver can receive the AIR, 144 MHz or 430 MHz bands.

You can transmit on only the 144 MHz and 430 MHz bands.

- You can make the selection on either the left or right band, regardless of the MAIN band.

Operating band	Frequency range
AIR	118.000 MHz to 136.99166 MHz
144 MHz	137.000 MHz to 174.000 MHz
430 MHz	375.000 MHz to 550.000 MHz

The ranges may differ, depending on the transceiver version.

- ① Push [V/MHz SCAN] [S].
 - Selects the VFO mode.
- ② Hold down [MAIN BAND] [S] for 1 second.
 - Enters the Operating band select mode.

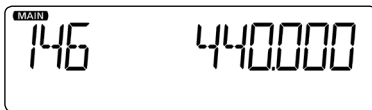

- ③ Rotate [DIAL] [S] to select the desired operating band.
- ④ Push [MAIN BAND] [S].
 - Returns to the stand-by mode.

■ Setting a frequency

This section describes on the VFO mode operation.
When you select other mode, push [V/MHz SCAN] [S].

◇ Selecting the 1 MHz tuning

You can change the operating frequency in 'MHz' steps for quick tuning.

- ① Push [V/MHz SCAN] [S].
 - Selects the 1 MHz tuning.

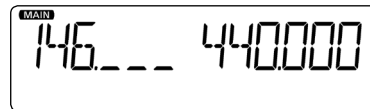

- ② Rotate [DIAL] [S].
 - The frequency changes in 1 MHz steps.
- ③ Push [V/MHz SCAN] [S].
 - Cancels the 1 MHz tuning.

3 BASIC OPERATION

■ Setting a frequency (Continued)

◇ Selecting a tuning step

Rotating [DIAL][S] changes the frequency in the selected tuning steps.

The VFO scan uses this step to search for a signal.

(pp. 37, 41)

- ① Push [MAIN BAND][S] on the band that the tuning step is set to.
- ② Push [MENU] [F-O] [C].
 - Enters the MENU mode.
- ③ Rotate [DIAL][S] to select “TS” (Tuning step).

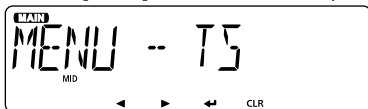

- ④ Push [↵][D].
 - Goes to the next tree level.
- ⑤ Rotate [DIAL][S] to select the desired value.
Selectable values (kHz):
5.0, 6.25, 8.33*, 10.0, 12.5, 15.0, 20.0, 25.0, 30.0, 50.0, or AUTO*.
*Appears only when the AIR band is selected.
- ⑥ Push [↵][D].
 - Sets the selected value, and goes back to the previous tree level.
- ⑦ Push [MAIN BAND][S].
 - Exits the MENU mode.
- ⑧ Rotate [DIAL][S].
 - The frequency changes in the selected tuning steps.

■ Setting audio volume and squelch level

• You can make the setting on either the left or right band, regardless of the MAIN band setting.

- ① Rotate [VOL][S] to adjust the audio level.
 - You can change the beep level in the “BEEPLY” (Beep Level) item of the MENU mode. (p. 16)
(MENU-EXMENU > EXMEN-SOUNDS > SOUND-BEEPLY)
- ② Rotate [SQL][S] until the noise and the “BUSY” icon just disappear.
 - Rotating [SQL][S] clockwise makes the squelch tight. Tight squelch is for strong signals.
 - When you rotate [SQL][S] clockwise beyond the center position, [SQL][S] becomes an ‘S-meter Squelch’ or ‘Attenuator.’ Select the [SQL][S] option in the MENU mode. (p. 14)

■ Lock function

You can use the Lock function to prevent accidental frequency changes and unnecessary function access on both the MAIN and SUB bands.

- ➡ Hold down [MENU] [F-O] [C] for 1 second.
 - “**F-O**” appears.
 - Hold down [MENU] [F-O] [C] again to cancel the function.
 - You can still use [U], [MONI DUP][C] (only the Monitor function canceling), [PTT], [MAIN BAND][S] (only the MAIN band selection), [MENU] [F-O] [C] (only the Lock function canceling), [SQL][S], and [VOL][S] while the Lock function is ON.

■ Transmitting

Before transmitting, monitor the operating frequency to see if other stations are on the frequency.

CAUTION: Transmitting without an antenna may damage the transceiver.

• You can transmit on only the 144 MHz and 430 MHz bands, and on the MAIN band.

- ① Push [LOW DTMF][C] to select the output power level.
 - Selectable levels: Low, Mid, and High
 - “LOW” is displayed when you select low power.
 - “MID” is displayed when you select mid power.
 - No icon is displayed when you select high power.
 - Lower output power during short-range communications may reduce the possibility of interference to other stations.
- ② Hold down [PTT] to transmit, and speak at your normal voice level.
 - The S/RF meter displays the output power level.

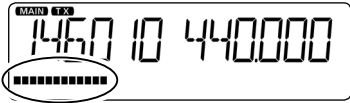

③ Release [PTT] to receive.

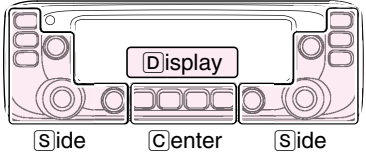

The [C], [S], or [D] in the instructions indicate the area of the controller.
 [C]: Center
 [S]: Side [D]: Display

■ Selecting the operating mode

The transceiver has a total of four operating modes, AM, AM-N, FM and FM-N. (Default: FM)

In the AIR band, the AM mode is set as a default. If the “AIR” (AIR band display) item is set to “CH ID” in EXMENU, you cannot select the operating mode.

• You can independently set the left and right bands when they are selected as the MAIN band.

- ① Push [MAIN BAND][S] of the band that the operating mode is set to.
- ② Push [MENU] [OFF] [C].
 - Enters the MENU mode.
- ③ Rotate [DIAL][S] to select “MODE” (Operating mode).

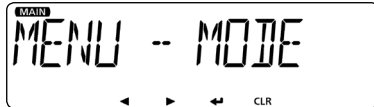

- ④ Push [ENTER] [D].
 - Goes to the next tree level.
- ⑤ Rotate [DIAL][S] to select the desired operating mode.

Selectable options:

In the 144 or 430 MHz band: FM or FM-N
 In the AIR band: AM or AM-N

 - While in the FM-N mode, the TX modulation is automatically set to approximately 2.5 kHz.
- ⑥ Push [ENTER] [D].
 - Sets the selected option, and goes back to the previous tree level.
- ⑦ Push [MAIN BAND][S].
 - Exits the MENU mode.

3 BASIC OPERATION

■ Audio mute function

This function temporarily mutes the audio without disturbing the volume setting.

• **This function is for both the MAIN and SUB bands.**

- Push [**MUTE**] to mute audio signals.
 - “MUTE” appear on the left and right bands.
 - Push [**MUTE**] (or any other key) to cancel the function.

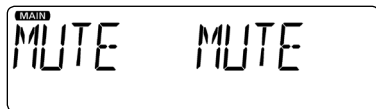

■ Monitor function

This function is used to listen to weak signals without disturbing the squelch setting.

• **This function is for the MAIN band.**

- Push [**MONI DUP**] to open or close the squelch.
 - “BUSY” blinks when the squelch is open.

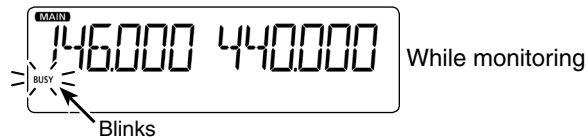

■ Setting the microphone gain level

Set the microphone gain level in the MENU mode.

- ① Push [**MENU**] to enter the MENU mode.
 - Enters the MENU mode.
- ② Rotate [**DIAL**] to select “MIC G” (MIC Gain).
(MENU-EXMENU > EXMEN-FUNC > FUNC-MIC G)

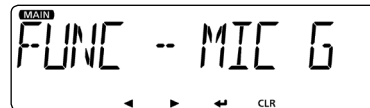

- ③ Push [**DOWN**] to go to the next tree level.
 - Goes to the next tree level.
- ④ Rotate [**DIAL**] to adjust the microphone gain level.
 - Set higher values to make the microphone more sensitive to your voice.
- ⑤ Push [**DOWN**] to set the selected value and go back to the previous tree level.
 - Sets the selected value, and goes back to the previous tree level.
- ⑥ Push [**MAIN BAND**] to exit the MENU mode.
 - Exits the MENU mode.

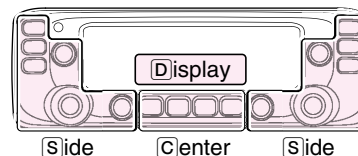

The **C**, **S**, or **D** in the instructions indicate the area of the controller.

- C**: Center
- S**: Side
- D**: Display

■ General description

The transceiver has a total of 1000 Memory channels (100 channels in each of 10 memory banks, A to J) and two Call channels (C0/C1) for the 144 and 430 MHz bands.

The Memory mode is useful to quickly select often-used frequencies.

◇ The number of the Memory channel

Memory Channels	Descriptions
000–999	Total of 1000 regular Memory channels Memory channels are selectable on either the left or right band, and usable for any operating band.
C0/C1	Two Call channels (C0: 144 MHz, C1: 430 MHz) Instantly recalls a specified frequency.

◇ Memory channel content

The following information can be entered into the Memory channels:

- Operating frequency
- Duplex direction (DUP or DUP–) and frequency offset
- Memory name
- Scan skip setting
- Tuning step
- Operating mode
- Subaudible tone encoder, tone squelch or DTCS squelch ON/OFF
- Subaudible tone frequency, tone squelch frequency or DTCS code with polarity
- Memory bank

4 MEMORY OPERATION

■ Selecting a Memory or Call channel

◇ Selecting a Memory channel

You can select a Memory channels by rotating [DIAL] [S] in the Memory mode.

• **Independently selectable on both the left and right bands.**

- ① Push [MR CALL] [S].
 - Selects the Memory mode.
- ② Rotate [DIAL] [S] to select a Memory channel.
 - Blank channels are not selected.

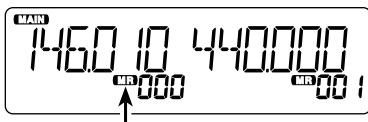

Appears

For your reference: Using the HM-207 microphone (p. 6)

- ① Push [VFO/MR] [S].
- ② Enter the Memory channel number, and then push [ENT].
 - When you enter a 3 digit channel number, pushing [ENT] is not necessary.

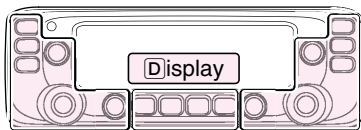

[S]ide

[C]enter

[S]ide

The [C], [S], or [D] in the instructions indicate the area of the controller.

[C]: Center

[S]: Side

[D]: Display

◇ Selecting a Call channel

You can select the Call channels (C0/C1) by rotating [DIAL] [S] in the Call channel mode.

Factory default frequencies and operating modes are preset into the Call channels.

Change these to suit your operating needs.

C0 is for VHF or AIR band, and C1 is for UHF band.

• **Independently selectable on both the left and right bands.**

- ① Hold down [MR CALL] [S] for 1 second.
 - Selects the Call channel mode.
- ② Rotate [DIAL] [S] to select a Call channel.

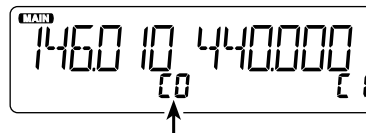

Displays the Call channel number

For your reference: Using the HM-207 microphone (p. 6)

- ① Hold down [HOME CALL] for 1 second to select the Call channel mode.
- ② Push [▲] or [▼] to select a Call channel.

■ Writing into a Memory or Call channel

After setting a frequency in the VFO mode, you can write it into your desired channel or an automatically selected blank channel.

Memory channels 002 to 999 are blank as the default.

Memory channels are independently selectable on both the left and right bands.

• **The operations are for the MAIN band.**

◇ Writing into the selected channel

Example: Writing 434.100 MHz into Memory channel “11.”

- ① Push [V/MHz SCAN][S].
 - Selects the VFO mode.
- ② Set the operating frequency to 434.100 MHz.
- ③ Push [MW][C].
 - “MR” blinks.

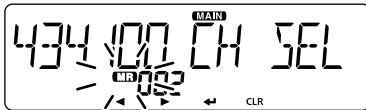

Blinks

- ④ Rotate [DIAL][S] to select “CH SEL.”
- ⑤ Push [↵][D].
 - Displays the Channel select screen.
 - Push [◀][D] to go back to the previous tree level.

- ⑥ Rotate [DIAL][S] to select channel “11.”

NOTE: If you select a pre-entered channel, the previous channel content will be displayed.

- You can also select Call channels.
- To select Bank channel, hold down [MAIN BAND][S] for 1 second.

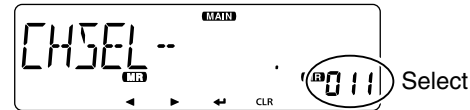

- ⑦ Push [↵][D].
- ⑧ Rotate [DIAL][S] to select “WRITE.”
- ⑨ Push [↵][D].
 - Displays “WRITE?”.
 - When you select a pre-entered channel in step ⑥, “OVERW?” is displayed.
- ⑩ Rotate [DIAL][S] to select “YES.”
- ⑪ Push [↵][D].
 - Beeps sound.
 - Writes into the selected channel, and returns to the VFO mode.

4 MEMORY OPERATION

■ Writing into a Memory or Call channel (Continued)

◇ Writing into a blank channel

Example: Writing 434.100 MHz into a blank channel.

- ① Push [V/MHz SCAN] [S].
 - Selects the VFO mode.
- ② Set the operating frequency to 434.100 MHz.
- ③ Hold down [MW] [C] for 1 second.
 - Automatically writes into a blank, and returns to the VFO mode.
 - Displays “MEMORY FULL” when no blank channel is found.



◇ Copying Memory content to the VFO

This is convenient when you want to change the frequency beginning near the Memory or Call channel frequency.

- ① Select a desired Memory channel to be copied. (p. 29)
- ② Push [MW] [C] to display the Memory entry screen.
- ③ Rotate [DIAL] [S] to select “TO VFO.”



- ④ Push [↵] [D].
 - Beeps sound.
 - Writes the selected Memory content to the VFO, and returns to the VFO mode.

◇ Copying Memory content to another Memory channel

You can copy the memory content to another Memory channel.

- ① Select the desired Memory channel to be copied. (p. 29)
- ② Push [MW] [C] to display the Memory entry screen.
- ③ Rotate [DIAL] [S] to select “COPY.”



- ④ Push [↵] [D].
- ⑤ Rotate [DIAL] [S] to select a target channel.
 - If you select a pre-entered channel, the previous channel content is displayed.

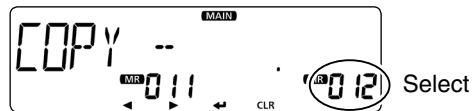

- ⑥ Push [↵] [D].
 - Beeps sound.
 - Copies to the destination channel.
 - When you select a pre-entered channel, “OVERW?” is displayed. Rotate [DIAL] [S] to select “YES,” and then push [↵] [D] to overwrite it.

■ Setting a Memory bank

The transceiver has a total of 10 banks (A to J). You can assign regular Memory channels 0 to 999 to any desired bank for easy memory management. You can assign up to 100 channels to a bank. It is convenient that you categorize the Memory bank, according to the Memory channel category or your purpose. You can use the Memory bank scan to scan the memory channels in the selected bank. (p. 43)

• **The operations are for the MAIN band.**

NOTE: The memory banks are only used to hold memory channels. Thus if the original memory channel content has been changed, the memory bank content is also changed at the same time.

For your reference:

To cancel your entry before assigning to or writing into a Memory bank.

- ① After entering, push [◀] or [CLR].
 - Displays the “CANCEL?”
- ② Rotate [DIAL] to select “YES.”
- ③ Push [↵].

◇ Assigning a Memory channel to a Memory bank

- ① Select the Memory channel to be assigned to a bank. (p. 29)
- ② Push [MW] to display the Memory entry screen.
- ③ Rotate [DIAL] to select “EDIT.”
- ④ Push [↵].
- ⑤ Rotate [DIAL] to select “BANK.”
- ⑥ Push [↵].
- ⑦ Rotate [DIAL] to select a desired bank group, “A” to “J.”

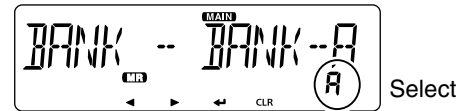

- ⑧ Push [↵].
- ⑨ Rotate [DIAL] to select “WRITE.”
- ⑩ Push [↵].
 - Displays “OVERW?.”
- ⑪ Rotate [DIAL] to select “YES.”
- ⑫ Push [↵].
 - Beeps sound.
 - Assigns the selected memory channel to the bank.

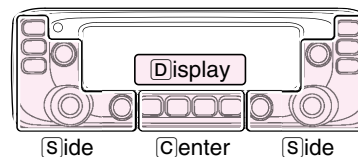

The [C], [S], or [D] in the instructions indicate the area of the controller.

- [C]: Center
- [S]: Side
- [D]: Display

4 MEMORY OPERATION

■ Setting a Memory bank (Continued)

◇ Directly entering into a Memory bank

You can also enter the memory content directly into a memory bank channel. This way is a short cut to creating a memory channel, and then assigning it to a bank.

In that case, the transceiver automatically selects the lowest blank memory channel, to enter content into.

Example: Writing 434.100 MHz into Bank group “A.”

- ① Push [V/MHz SCAN]**[S]**.
 - Selects the VFO mode.
- ② Set the operating frequency to 434.100 MHz.
- ③ Push [MW]**[C]** to display the Memory write screen.
- ④ Rotate [DIAL]**[S]** to select “BANK.”
- ⑤ Push [↵]**[D]**.
- ⑥ Rotate [DIAL]**[S]** to select a Bank group “A.”

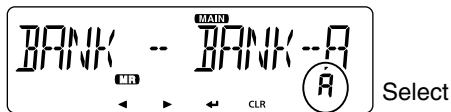

- ⑦ Push [↵]**[D]**.
- ⑧ Rotate [DIAL]**[S]** to select “WRITE.”
- ⑨ Push [↵]**[D]**.
 - Displays “WRITE?”
- ⑩ Rotate [DIAL]**[S]** to select “YES.”
- ⑪ Push [↵]**[D]**.
 - Sounds beeps, writes the memory content to the bank channel, and returns to the VFO mode.

◇ Selecting the Memory bank mode

When you select the Memory bank mode, rotating [DIAL]**[S]** selects only the bank channels assigned to the selected bank.

- ① Push [MR CALL]**[S]**.
 - Selects the Memory mode.
- ② Hold down [MAIN BAND]**[S]** for 1 second.
- ③ Rotate [DIAL]**[S]** to select a desired Bank group.
 - Displays the Bank name, if entered.

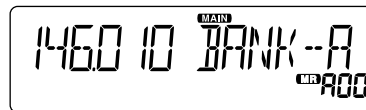

- ④ Push [MAIN BAND]**[S]**.
 - Selects the Memory bank mode.
- ⑤ Rotate [DIAL]**[S]** to select a desired Bank channel.
 - Blank channels are not displayed.
 - To return to the Memory channels display, select a Memory channel in step ③.

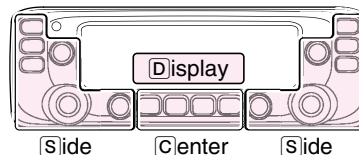

The **[C]**, **[S]**, or **[D]** in the instructions indicate the area of the controller.

- [C]**: Center
- [S]**: Side
- [D]**: Display

■ Entering a Memory or Bank name

You can enter an alphanumeric name for each Memory channel, Call channel, and Bank.

Names can up to 6 characters.

• The operations are for the MAIN band.

- ① Select a Memory channel to enter a name.
 - To enter a Bank name, select a Bank group.
- ② Push [MW][C] to display the Memory entry screen.
- ③ Rotate [DIAL][S] to select “EDIT.”
- ④ Push [↵][D].
- ⑤ Rotate [DIAL][S] to select “NAME.”
 - To enter a Bank name, select “B NAME.”
- ⑥ Push [↵][D].
- ⑦ Rotate [DIAL][S] to select a desired character or symbol.

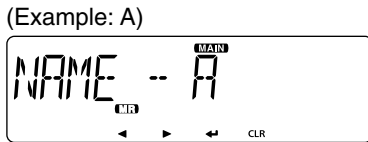

When entering a Memory name

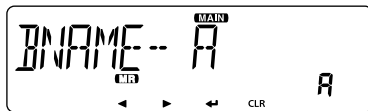

When entering a Bank name

• Selectable characters and symbols:

A	B	C	D	E	F	G	H	I	J	K	L	M
[A]	[B]	[C]	[D]	[E]	[F]	[G]	[H]	[I]	[J]	[K]	[L]	[M]
N	O	P	Q	R	S	T	U	V	W	X	Y	Z
[N]	[O]	[P]	[Q]	[R]	[S]	[T]	[U]	[V]	[W]	[X]	[Y]	[Z]
0	1	2	3	4	5	6	7	8	9	"	#	
[0]	[1]	[2]	[3]	[4]	[5]	[6]	[7]	[8]	[9]	["]	[#]	
\$	%	&	'	()	*	+	-	\	/	:	
[\$]	[%]	[&]	[']	[()]	[*]	[+]	[-]	[\\]	[/]	[:]	
/	<	=	>	?	@	[]	[\]	^	_			
[/]	[<]	[=]	[>]	[?]	[@]	[]	[\]	[^]	[_]	[Space]		

- Push [CLR][D] to delete the selected character or symbol.
- When no character or symbol is selected, push [▶][D] to enter a space.
- ⑧ Push [◀] to move the cursor backwards, or push [▶] to move the cursor forwards.
- ⑨ Repeat steps ⑦ and ⑧ to enter a name of up to 6 characters, including spaces.
- ⑩ After entering, push [↵][D].
- ⑪ Rotate [DIAL][S] to select “WRITE.”
- ⑫ Push [↵][D].
 - Displays “OVERW?.”
- ⑬ Rotate [DIAL][S] to select “YES.”
- ⑭ Push [↵][D].
 - Sounds beeps, writes the entered name to the channel, and returns to the VFO mode.

For your reference: To display the entered name

Turn ON the “NAME” (Memory Name) item of EXMENU.
(MENU-EXMENU > EXMENU-DISP > DISP-NAME)

4 MEMORY OPERATION

■ Clearing a Memory channel

Entered memory content can be cleared (erased), if desired.

NOTE: Once you clear a memory content, it cannot be recovered.

• The operations are for the MAIN band.

- ① Push [MR CALL]**S**.
 - Selects the Memory mode.
 - When you clear a Call channel, hold down [MR CALL]**S** for 1 second to select the Call channel mode.
- ② Push [MW]**C** to display the Memory entry screen.
- ③ Rotate [DIAL]**S** to select "CLEAR."
- ④ Push [↵]**D**.
- ⑤ Rotate [DIAL]**S** to select a desired channel to be cleared.



- ⑥ Push [↵]**D**.
 - Displays "CLEAR?"
- ⑦ Rotate [DIAL]**S** to select "YES."
- ⑧ Push [↵]**D**.
 - Beeps sound.
 - Clears the memory content.

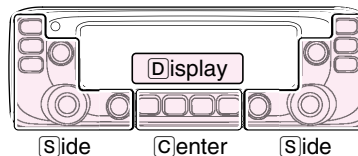

The **C**, **S**, or **D** in the instructions indicate the area of the controller.

C: Center

S: Side

D: Display

■ About the scan function

◇ VFO scan (p. 41)

- **ALL** (Full scan)
Repeatedly scans the entire band.

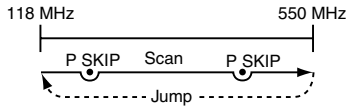

- **BAND** (Selected band scan)
Scans all frequencies over the entire selected band.

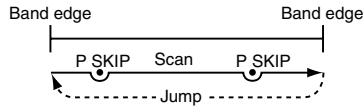

- **PROG 0 ~ 24** (Program scan)
Scans the program scan edge range.

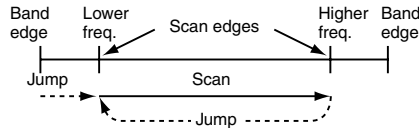

- **P-LINK0 ~ 9** (Program link scan)
Sequentially scans the program scan edge ranges which are set to link in the “P-LINK” (Program Link) item of the EXMENU mode. (p. 14)

For your reference: The frequencies that are set as “PSKIP” are not scanned. (p. 13)

NOTE: At least one program scan edge range must be programmed to start a program scan. (p. 38)

◇ Memory scan (p. 43)

- **ALL** (Full memory scan)
Scans all Memory channels.
- **BAND** (Selected band memory scan)
Scans all Memory channels in the same frequency band as the selected channel.
- **MODE** (Mode memory scan)
Scans Memory channels that are programmed with the same receiving mode as the currently selected mode.

◇ Memory bank scan (p. 43)

- **ALL** (Full bank scan)
Scans all banks.
- **B-LINK** (Bank link scan)
Sequentially scans the banks that are set to link in the “B-LINK” (Bank Link) item of the EXMENU mode.
- **BANK-A ~ J** (Bank scan)
Scans the Memory channels in the selected bank.

For your reference: The frequencies that are set as “PSKIP” or “SKIP” are not scanned. (p. 44)

NOTE: Two or more memory channels must be programmed to start a Memory scan.

5 SCAN OPERATION

■ About the scan function (Continued)

[Duplex (DUP) scan]

The Duplex scan searches for both TX and RX frequencies that are used in duplex operation. (p. 50)

- The “DUP–” or “DUP” icon is displayed in the duplex mode.
- A duplex scan will not start if the frequency offset is set to “0.000 MHz.”

[Tone scan]

The tone scan searches for tone frequencies or DTCS codes that are used by stations using the Tone Squelch function. You can use a tone scan in the VFO, Memory or Call channel modes.

Refer to page 56 for details of the Tone Squelch function.

◇ [DIAL] operation during a scan

- If desired, rotate [DIAL] [S] to change the scanning direction during a scan.
- When the scan is paused, rotate [DIAL] [S] to resume the scan.

◇ Tuning step for a VFO scan

The selected tuning step is applied to the scan.

For a program scan or program link scan, set the tuning step in the program scan edge ranges. (p. 40)

(MENU-EXMENU > EXMEN-SCAN > SCAN-P-EDGE)

◇ Skip function

The skip function speeds up scanning by not scanning those frequencies set as skip channels. (pp. 42, 44)

For your reference:

When the “P-SKIP” (Program Skip) item is set to OFF, the Scan Skip function cannot be used. (p. 13)

◇ Scan Stop Beep function

The Scan Stop Beep function sounds a beep when a signal is received.

The function can be turned ON or OFF in the “STOP B” (Scan Stop Beep) item of the EXMENU mode. (p. 16)

◇ **Receive mode during a scan**

- The selected mode is used by the scan.
- During a memory or bank scan, the channel's mode is used by the scan.

Scanning in the FM mode

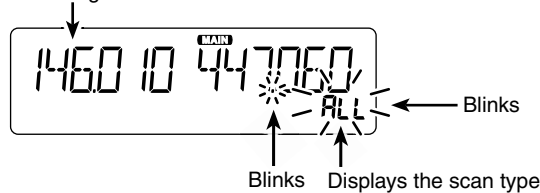

◇ **When a signal is received**

When a signal is received, the scan pauses for approximately 10 seconds (default), and then resumes.

The scan resumes approximately 2 seconds (default) after the signal disappears.

To manually resume the scan, rotate [DIAL] [S].

- These settings can be changed in the “PAUSE” (Pause Timer) item or “RESUME” (Resume Timer) item of the MENU mode. (pp. 12, 21)

◇ **Scan name**

A desired name can be entered to each Program scan edge. (p. 39)

When the scan name is entered, it is displayed on the scan type setting screen.

■ **Entering scan edges**

Enter the higher and lower frequency edges as the scan edge range for programmed scans.

Each program scan has its own tuning step and operating mode settings.

The default settings differ, depending on the transceiver version.

You can enter a total of up to 25 program scan.

➡ Continued on the next page

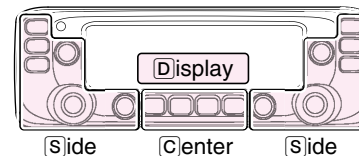

The [C], [S], or [D] in the instructions indicate the area of the controller.

- [C]: Center
- [S]: Side
- [D]: Display

5 SCAN OPERATION

■ Entering scan edges (Continued)

1. Entering a scan name

- ① Push [MENU] [C].
 - Enters the MENU mode.
- ② Rotate [DIAL] [S] to select “P-EDGE” (Program Scan Edge). (MENU-EXMENU > EXMEN-SCAN > SCAN-P-EDGE)
- ③ Push [↵] [D].
 - Goes to the next tree level.
- ④ Rotate [DIAL] [S] to select a desired scan edge channel. (Example: P03)

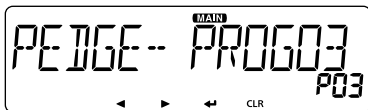

- ⑤ Push [↵] [D].
 - Goes to the next tree level.
 - Push [◀] [D] to go back to the previous tree level.
- ⑥ Rotate [DIAL] [S] to select “NAME.”
- ⑦ Push [↵] [D] to display the Scan name entry screen.
- ⑧ Rotate [DIAL] [S] to select a desired character or symbol. (Example: SCAN03)

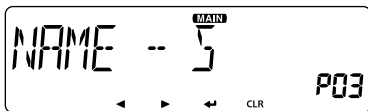

Scan name entry screen

- Selectable characters and symbols:

A	B	C	D	E	F	G	H	I	J	K	L	M
[A]	[B]	[C]	[D]	[E]	[F]	[G]	[H]	[I]	[J]	[K]	[L]	[M]
N	O	P	Q	R	S	T	U	V	W	X	Y	Z
[N]	[O]	[P]	[Q]	[R]	[S]	[T]	[U]	[V]	[W]	[X]	[Y]	[Z]
0	1	2	3	4	5	6	7	8	9	"	#	
[0]	[1]	[2]	[3]	[4]	[5]	[6]	[7]	[8]	[9]	[!]	["]	[#]
\$	%	&	'	()	*	+	,	--	\	/	
[\$]	[%]	[&]	[']	[(]	[)]	[*]	[+]	[,]	[-]	[\]	[/]	[]
/	<	=	>	?	@	[\]	^	_		
[/]	[<]	[=]	[>]	[?]	[@]	[[]	[\]	[]]	[^]	[_]	[Space]	

- Push [CLR] [D] to delete the selected character or symbol.
 - When no character or symbol is selected, push [] [D] to enter a space.
- ⑨ Push [◀] to move the cursor backwards, or push [▶] to move the cursor forwards.
 - ⑩ Repeat steps ⑦ and ⑧ to enter a name of up to 6 characters, including spaces.
 - ⑪ After entering, push [↵] [D].

2. Entering program scan edges

NOTE: You must enter different frequencies in “FREQ L” and “FREQ H,” to specify a scanning frequency range. If identical frequencies are entered, the Program scan will not work.

- ⑫ Rotate [DIAL] [S] to select “FREQ L.”
- ⑬ Push [↵] [D] to display the Lower edge frequency setting screen.

- ⑭ Rotate [DIAL] [S] to select a desired number.
- ⑮ Push [◀] to move the cursor backwards, or push [▶] to move the cursor forwards.
- ⑯ Repeat steps ⑭ and ⑮ to enter a lower edge frequency. (Example: 375.000)
- ⑰ After entering, push [↵] [D].



- ⑱ Rotate [DIAL] [S] to select “FREQ H,” and enter a higher edge frequency in the same way as steps ⑬ and ⑮.
- ⑲ After entering, push [↵] [D].

3. Setting a tuning step

NOTE: If the frequencies entered in “FREQ L” and “FREQ H” are on a different band, the Tuning step setting screen does not appear. In this case, the VFO mode’s tuning step for each band is used during a scan.

- ⑳ Rotate [DIAL] [S] to select “TS.”
- ㉑ Push [↵] [D] to display the Tuning step setting screen.
- ㉒ Rotate [DIAL] [S] to select a desired tuning step to be used while program scanning.

Selectable value (kHz):

5.0, 6.25, 8.33*, 10.0, 12.5, 15.0, 20.0, 25.0, 30.0, 50.0, or AUTO*.

* Appears only when the AIR band is selected.

- ㉓ After selecting, push [↵] [D].

4. Setting a operating mode

NOTE:

- If the frequencies entered in “FREQ L” and “FREQ H” are on a different band, the Operating mode setting screen does not appear. In this case, the VFO mode’s operating mode for each band is used during a scan.
- When the entered frequencies are in the AIR band, the operating mode is automatically set, and the setting screen does not appear.

- ㉔ Rotate [DIAL] [S] to select “MODE.”
- ㉕ Push [↵] [D] to display the Operating mode setting screen.
- ㉖ Rotate [DIAL] [S] to select a desired operating mode.
- ㉗ After selecting, push [↵] [D].

5. Entering the scan edge

- ㉘ Rotate [DIAL] [S] to select “WRITE.”
- ㉙ Push [↵] [D].
 - Displays “WRITE?.”
- ㉚ Rotate [DIAL] [S] to select “YES.”
- ㉛ Push [↵] [D].
 - Beeps sound.
 - Enters the scan edges, and returns to the Scan edge channel select screen.

The [C], [S], or [D] in the instructions indicate the area of the controller.

[C]: Center, [S]: Side, [D]: Display

5 SCAN OPERATION

■ VFO mode scan

There are 6 scan types: Full scan, Band scan, Program scan, Program link scan, Duplex scan and Tone scan.

NOTE:

- The frequencies that are set as “PSKIP” channels are skipped during a scan.
- When the “P-SKIP” (Program Skip) item in the EXMENU is set to OFF, even the frequencies that are set as “PSKIP” channels are scanned.

◇ VFO mode scan

- ① Push [V/MHz SCAN] [S].
 - Selects the VFO mode.
- ② Hold down [V/MHz SCAN] [S] for 1 second.
 - Displays the scan type setting screen.
- ③ Rotate [DIAL] [S] to select a desired scan type.
 - ALL: Full scan
 - BAND: Band scan
 - P-LINK0 ~ 9: Program link scan
 - PROG00 ~ PROG24: Program scan
 - DUP: Duplex scan (p. 50)
(Appears only when duplex is set.)
 - TONE: Tone scan
- ④ Push [V/MHz SCAN] [S] to start the scan.
- ⑤ To cancel the scan, push [V/MHz SCAN] [S].

While scanning

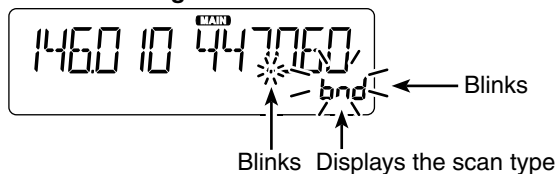

When receiving a signal

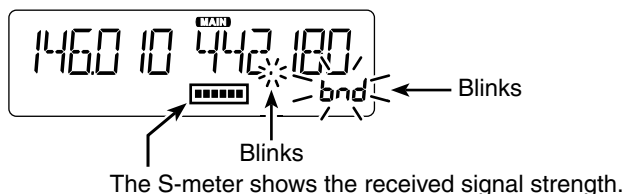

When a scan name is assigned. (p. 13)

When a scan name is assigned, it is displayed on the scan type setting screen. (Step ③ on this page)

See page 39 to enter a scan name.

When a program link name is assigned. (p. 14)

When a program link name is assigned, it is displayed on the scan type setting screen. (Step ③ on this page)

See the Icom website to enter a program link name.

■ Setting and clearing the skip frequencies

◇ Setting the skip frequencies

The frequencies set as “PSKIP” channels are not scanned.

- ① Start the VFO scan. (p. 41)
 - When a signal is received, the scan pauses.
- ② To skip the frequency, hold down [MW] [C] for 1 second (until 3 beeps sound) while the scan is paused.
 - When a signal is received during the scan, the transceiver attempts to enter the frequency as a skip channel into empty memory channel 999.

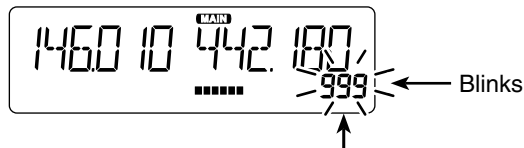

Skip frequency is entered into channel 999.

- If channel 999 already has content, the transceiver automatically searches for another blank channel to enter. If no blank memory channel is found, a beep sounds, and no skip channel is set.
- ③ After the skip channel is set, the scan resumes.

The [C], [S], or [D] in the instructions indicate the area of the controller.

[C]: Center, [S]: Side, [D]: Display

◇ Clearing the skip frequencies

- ① Push [MR CALL] [S].
 - Selects the Memory mode.
- ② Rotate [DIAL] [S] to select the memory channel you want to clear as a skip channel. (Example: 999)

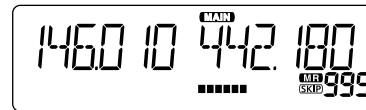

- ③ Push [MW] [C] to display the Memory edit screen.
- ④ Rotate [DIAL] [S] to select “EDIT.”
- ⑤ Push [↵] [D].
- ⑥ Rotate [DIAL] [S] to select “SKIP.”
- ⑦ Push [↵] [D].
- ⑧ Rotate [DIAL] [S] to select “OFF.”
- ⑨ Push [↵] [D].
- ⑩ Rotate [DIAL] [S] to select “WRITE.”
 - Displays “OVERW?.”
- ⑪ Rotate [DIAL] [S] to select “YES.”
- ⑫ Push [↵] [D].
 - Beeps sound.
 - Clears the skip setting.

For your reference:

The skip setting is also cancelled when the memory channel set as a skip channel is deleted. (p. 35)

5 SCAN OPERATION

Memory scan

There two types of scans in the memory mode, Memory scan and Memory bank scan.

Memory (skip) scan

Repeatedly scans all programmed Memory channels.

• Two or more memory channels, which are not set as skip channels, must be programmed into start a memory scan.

- ① Push [MR CALL] [S] .
 - Selects the Memory mode.
- ② Hold down [V/MHz SCAN] [S] for 1 second.
 - Displays the scan type setting screen.
- ③ Rotate [DIAL] [S] to select a desired scan type.
 - ALL: Full scan
 - BAND: Band memory scan
 - MODE: Mode memory scan
 - DUP: Duplex scan (p. 50)
(Appears only when duplex is set.)
 - TONE: Tone scan
- ④ Push [V/MHz SCAN] [S] to start the scan.
- ⑤ To cancel the scan, push [V/MHz SCAN] [S] .

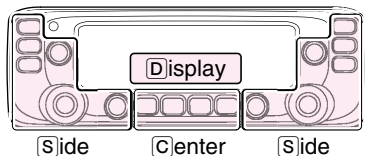

The [C] , [S] , or [D] in the instructions indicate the area of the controller.

- [C] : Center
- [S] : Side
- [D] : Display

Memory bank scan

A memory bank scan searches through the memory channels in the selected bank.

• Two or more memory channels, that are not set as skip channels, must be programmed to start a memory bank scan.

- ① Push [MR CALL] [S] .
 - Selects the Memory mode.
- ② Hold down [MAIN BAND] [S] for 1 second.
- ③ Rotate [DIAL] [S] to select the desired Bank group.
- ④ Push [MAIN BAND] [S] .
 - Selects the Memory bank mode.
- ⑤ Hold down [V/MHz SCAN] [S] for 1 second.
 - Displays the scan type setting screen.
- ⑥ Rotate [DIAL] [S] to select a desired scan type.
 - ALL: Full bank scan
 - B-LINK: Bank link scan
 - BANK-A ~ BANK-J:
Bank scan
(Only banks which contain memory channels are displayed.)
 - DUP: Duplex scan (p. 50)
(Appears only when duplex is set.)
 - TONE: Tone scan
- ⑦ Push [V/MHz SCAN] [S] to start the scan.
- ⑧ To cancel the scan, push [V/MHz SCAN] [S] .

When a bank name is assigned.

The name is displayed on the scan type setting screen. See page 34 to enter the bank name.

■ Setting and clearing skip channels

The channels that are set as “SKIP” or “PSKIP” channels are skipped (not scanned).

- ① Push [MR CALL][S].
 - Selects the Memory mode.
- ② Rotate [DIAL][S] to select a memory channel to be set.
- ③ Hold down [MW][C] for 1 second to display the Memory edit screen.
- ④ Push [↵][D].
- ⑤ Rotate [DIAL][S] to select “SKIP.”
- ⑥ Push [↵][D].
- ⑦ Rotate [DIAL][S] to select a desired option.
 - OFF: Cancel the skip setting.
 - SKIP: Skipped during a memory scan.
 - PSKIP: Skipped during both VFO and memory scans.
- ⑧ Rotate [DIAL][S] to select “WRITE.”
 - Displays “OVERW?”
- ⑨ Rotate [DIAL][S] to select “YES.”
- ⑩ Push [↵][D].
 - Beeps sound, and sets the skip setting.
 - “SKIP” appears.
 - When you select “OFF” in step ⑦, no icon appears.

■ Setting the temporary skip function

This function temporarily skips up to five unwanted frequencies during a scan, for the set time period, without setting the skip frequency.

This function can be used only when the HM-207 (supplied), HM-154 (optional) microphone or VS-3 Bluetooth® HEADSET is connected.

- ① Start a VFO scan. (p. 41)
 - When a signal is received, the scan pauses.
- ② While the scan is pausing, push the key that the “T-SKIP” (Temporary Skip) function is assigned to.
 - The Temporary skip function is set.
- ③ After setting the temporary skip function, the scan resumes.
 - After the Temporary Skip time period passes, or the scan is cancelled, the Temporary Skip is also cancelled.

For your reference:

- Up to five Temporary Skip frequencies or memories can be set.
- During a Memory scan, follow steps ② and ③ to skip the channel for the set time period (Default: 5 minutes).
- The Temporary Skip time period is set to “5 minutes” by default. You can change the setting in the “TEMP” (Temporary Skip Timer) item of EXMENU mode. (p. 13)

Priority watch

While operating on a VFO frequency or while scanning, Priority watch checks for signals on a selected frequency every 5 seconds.

- You can make a Priority watch independently on both the left and right bands.
- This section describes the MAIN band operation.

◇ VFO and a Priority channel (p. 46)

Checks the selected Priority channel every 5 seconds, while receiving on a VFO frequency, or during a VFO mode scan. A Memory channel, Bank channel or Call channel can be selected as the Priority channel.

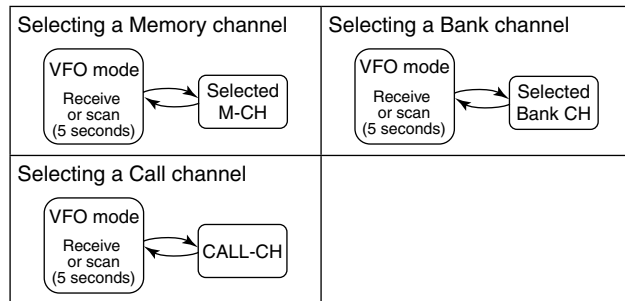

◇ VFO and a Memory/Bank scan (p. 47)

Sequentially checks the Memory or Bank channels every 5 seconds, while receiving on a VFO frequency or during a VFO mode scan.

A Memory scan or Bank scan can be selected.

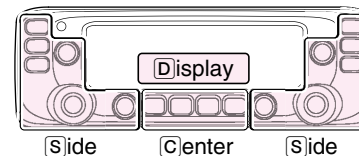
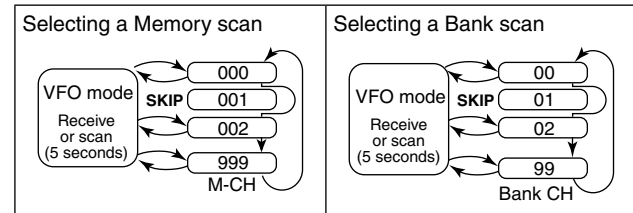

The **C**, **S**, or **D** in the instructions indicate the area of the controller.

C: Center

S: Side

D: Display

■ VFO and a Priority channel

◇ VFO frequency and a Priority channel

Checks the selected Priority channel every 5 seconds, while receiving on a VFO frequency.

- ① Set the VFO frequency. (p. 24)
- ② Set the Priority channel. (p. 29)
 - Select a Memory channel, Bank channel or Call channel.
- ③ Push [MENU] [C].
 - Enters the MENU mode.
- ④ Rotate [DIAL] [S] to select “PRIO” (Priority scan).
- ⑤ Push [J] [D].
- ⑥ Rotate [DIAL] [S] to select “ON” or “Bell.”
 - ON: Starts Priority Watch.
 - Bell: Starts Priority Watch.

When a signal is received on the Priority channel, the “**PRIO**” icon appears on the display.
- ⑦ Push [J] [D].
- ⑧ Push [MAIN BAND] [S].
 - Exits the MENU mode.
 - The “PRIO” icon appears, and the Priority watch starts.
 - To cancel the Priority watch, select “OFF” in step ⑥.

Example: Checks Memory channel “11” while receiving on 433.920 MHz.

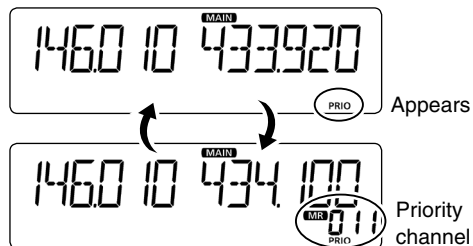

Checks the Memory channel every 5 seconds.

◇ VFO scan and a Priority channel

Checks the selected Priority channel every 5 seconds, during a VFO mode scan.

- ① Do steps ① through ⑧ as shown to the left.
 - The “PRIO” icon appears, and the Priority watch starts.
- ② Hold down [V/MHz SCAN] [S] for 1 second.
- ③ Rotate [DIAL] [S] to select a desired scan type.
- ④ Push [V/MHz SCAN] [S].
 - The VFO scan starts.

■ VFO and a Memory/Bank scan

◇ VFO frequency and a Memory/Bank scan

Sequentially checks the Memory or Bank channels every 5 seconds, while receiving on a VFO frequency.

- ① Set the VFO frequency. (p. 24)
- ② Select the Memory mode. (p. 23)
- ③ Hold down [V/MHz SCAN][S] for 1 second.
- ④ Rotate [DIAL][S] to select a desired scan type.
- ⑤ Push [V/MHz SCAN][S].
 - The Memory scan starts.
- ⑥ Push [MENU][C].
 - Enters the MENU mode.
- ⑦ Rotate [DIAL][S] to select “PRIO” (Priority scan).
- ⑧ Push [↵][D].
- ⑨ Rotate [DIAL][S] to select “ON” or “Bell.”
 - ON: Starts Priority Watch.
 - Bell: Starts Priority Watch.

When a signal is received on the Priority channel, the “(•••)” icon appears on the display.
- ⑩ Push [↵][D].
- ⑪ Push [MAIN BAND][S].
 - Exits the MENU mode.
 - The “PRIO” icon appears, and the Priority watch starts.
 - To cancel the Priority watch, select “OFF” in step ⑨.

Example: Sequentially checks the Memory channels while receiving on 433.920 MHz.

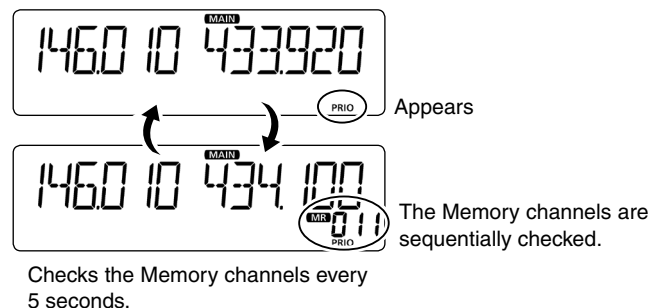

◇ VFO scan and a Memory/Bank scan

Sequentially checks the Memory or Bank channels every 5 seconds during a VFO scan.

- ① Do steps ① through ⑪ as shown to the left.
 - The “PRIO” icon appears, and the Priority watch starts.
- ② Hold down [V/MHz SCAN][S] for 1 second.
- ③ Rotate [DIAL][S] to select a desired scan type.
- ④ Push [V/MHz SCAN][S].
 - The VFO scan starts.

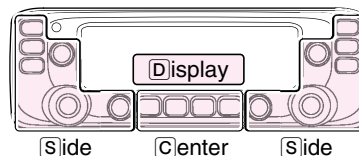

The [C], [S], or [D] in the instructions indicate the area of the controller.

- [C]: Center
- [S]: Side
- [D]: Display

■ Repeater operation

A repeater receives signals on one frequency, and then re-transmits them on a different frequency. When using a repeater, the transmit frequency is shifted from the receive frequency by the frequency offset.

You can access a repeater using the Duplex function by setting the transceiver's offset to the same value as the repeater's offset.

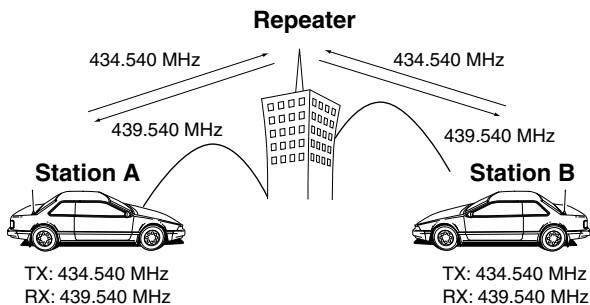

- ① Select the VFO mode. (p. 23)
- ② Select the operating band. (p. 24)
- ③ Select the FM mode. (p. 26)
- ④ Rotate [DIAL] [S] to set the receive frequency (Repeater output frequency).
 - When the Auto Repeater function* is turned ON, steps ⑧ and ⑨ are not necessary. (p. 52)

*Available in only the U.S.A. and Korea versions.

- ⑤ Hold down [MONI DUP] [C].
 - Displays the duplex direction setting screen. (p. 50)
- ⑥ Rotate [DIAL] [S] to select a desired offset direction.
 - “DUP-” or “DUP” appears.
 - You can set the frequency offset in the MENU mode. (p. 50)
- ⑦ Push [MONI DUP] [C].
 - Sets the selected offset direction.
- ⑧ Enters the MENU mode. (p. 11)
- ⑨ Rotate [DIAL] [S] to select “TONE” (Tone).
- ⑩ Push [J] [D].
- ⑪ Rotate [DIAL] [S] to select “TONE” (Repeater tone).

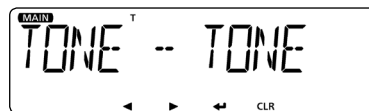

- “T” appears.
 - You can set the tone frequency in the MENU mode. (p. 19)
- ⑫ Push [J] [D].
 - Sets the selected value, and goes back to the previous tree level.
 - ⑬ Push [MAIN BAND] [S].
 - Turns ON the repeater tone, and exits the MENU mode.
 - ⑭ Operate normally.
 - The subaudible tone is superimposed on your transmit signal.

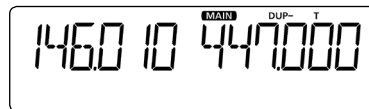

7 REPEATER AND DUPLEX OPERATIONS

■ Repeater operation (Continued)

For your reference:

- If the Repeater tone frequency or the frequency offset is changed, the tone or offset for the Auto Repeater function is also changed.
- If the offset value will cause the transmit frequency to be out of the band, “OFF” will appear on the display when [PTT] is pushed, and transmit will be inhibited. (p. 51)

◇ Checking the repeater input signal

You can check whether another station’s transmit signal can be received directly or not, by listening to the repeater input frequency.

➔ Push [MONI DUP]**C** to listen on the repeater input frequency.

- While monitoring, “BUSY” blinks.
- While monitoring, the displayed frequency automatically changes to the transceiver transmit frequency (repeater input frequency).
- When the other station’s signal can be directly received, move to a non-repeater frequency and use simplex. (Duplex OFF)
- While monitoring, the Attenuator function is temporarily disabled to receive a weak signal.

While monitoring

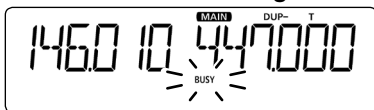

◇ 1750 Hz tone burst

A 1750 Hz tone is required to access many European repeaters.

This function can be used only when the supplied HM-207 or optional HM-154 microphone is connected.

- ① Select the FM mode. (p. 26)
- ② Push [PTT] on the microphone to transmit, and then push the key that the “T-CALL” function is assigned to access the repeater with a short tone burst.
 - See page 8 for microphone key assignment details.
- ③ Operate normally.
 - The S/RF meter displays the output power level.

Sending the tone burst

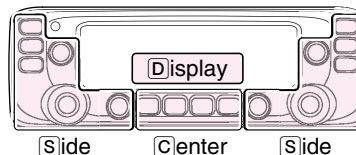
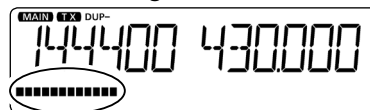

The **C**, **S**, or **D** in the instructions indicate the area of the controller.

C: Center

S: Side

D: Display

■ Duplex operation

The Duplex operation shifts the transmit frequency up or down from the receive frequency by an offset amount.

• **This section describes the MAIN band operation.**

◇ Setting the frequency offset

- ① Enters the MENU mode. (p. 11)
- ② Rotate [DIAL] [S] to select "OFFSET" (Frequency Offset).

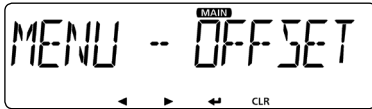

- ③ Push [↵] [D].
 - Goes to the next tree level.



- ④ Rotate [DIAL] [S] to set a desired frequency offset.
 - Set to between 0.000.00 and 59.995 MHz.
 - The selected tuning step in the VFO mode is used when setting the frequency offset.
- ⑤ Push [↵] [D].
 - Sets the selected value, and goes back to the previous tree level.
- ⑥ Push [MAIN BAND] [S].
 - Exits the MENU mode.

◇ Setting the duplex direction

- ① Hold down [MONI DUP] [C].
 - Displays the duplex direction setting screen.

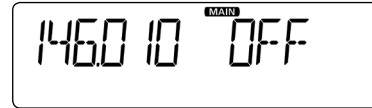

- ② Rotate [DIAL] [S] to select a desired option.
 - OFF: For simplex operation (the receive and transmit frequencies are the same).
 - DUP-: The transmit frequency shifts down from the receive frequency by the offset amount. ("DUP-" appears.)
 - DUP+: The transmit frequency shifts up from the receive frequency by the offset amount. ("DUP" appears.)

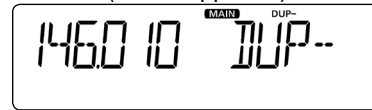

- ③ Push [MONI DUP] [C].
 - Sets the selected offset direction.

7 REPEATER AND DUPLEX OPERATIONS

■ Duplex operation (Continued)

◇ Duplex operation

- ① Push [MONI DUP]**C** to listen to the transmit frequency to check whether another station is transmitting on it, or not.
 - The transceiver transmit frequency appears on the display.
- ② Push [MONI DUP]**C** again to stop monitoring, and then operate normally.

NOTE: When the Auto repeater function is ON, and the operating frequency is set out of the repeater output frequency range, the duplex mode is automatically cancelled.

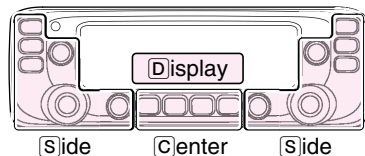

The **C**, **S**, or **D** in the instructions indicate the area of the controller.

C: Center

S: Side

D: Display

■ Off band indication

If the transmit frequency is out of the amateur band, the off band indication, "OFF," appears on the display when [PTT] is pushed. Check the frequency offset or duplex direction in this case. (p. 50)

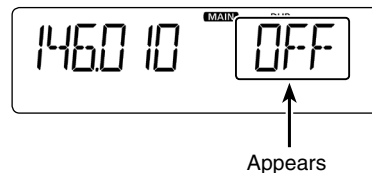

■ Auto repeater function

When the operating frequency falls within the repeater output frequency range, the Auto Repeater function automatically sets the repeater settings (duplex ON/OFF, duplex direction, tone encoder ON/OFF).

The Auto repeater function uses the preset repeater tone frequency and frequency offset.

- ① Enters the MENU mode. (p. 11)
- ② Rotate [DIAL] [S] to select “AUTORP” (Auto Repeater).
(MENU-EXMENU > EXMEN-FUNC > FUNC-AUTORP)

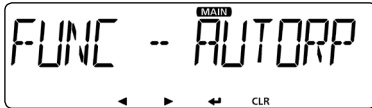

- ③ Rotate [DIAL] [S] to select a desired option to turn ON the Auto Repeater function.

USA version:

- OFF: The Auto repeater function is OFF.
- DUP: Turns ON only the duplex operation. (Default)
- DUP.TONE: Turns ON the duplex operation and tone encoder

Korean version:

- OFF: The Auto repeater function is OFF.
- ON: Turns ON the duplex operation and tone encoder. (Default)

- ⑤ Push [↵] [D].
 - Sets the selected option, and goes back to the previous tree level.
- ⑥ Push [MAIN BAND] [S].
 - Exits the MENU mode.

For the U.S.A. and Korean versions:

When turned ON, the Auto repeater function has priority over the manual duplex setting. If the transmit frequency changes after setting, the Auto repeater function may have changed the duplex setting.

◇ Frequency range and offset direction

• U.S.A. version

FREQUENCY RANGE	SHIFT DIRECTION
145.200–145.495 MHz	“DUP–” is set
146.610–146.995 MHz	“DUP–” is set
147.000–147.395 MHz	“DUP+” is set
442.000–444.995 MHz	“DUP+” is set
447.000–449.995 MHz	“DUP–” is set

• Korean version

FREQUENCY RANGE	SHIFT DIRECTION
439.000–440.000 MHz	“DUP–” is set

■ Home Channel Beep function

When you select a Home channel by rotating [DIAL]Ⓢ, a beep sounds. You will know the Home channel is selected without looking at the display.

In the AIR band, the Home channel beep sounds only when the frequency or the operating mode (AM or AM-N) same as the Home channel is selected.

◇ Setting the Home channel

A Home channel can be set in both the VFO mode and Memory mode.

- ① Set a desired frequency and operating mode to be set as a Home channel in the VFO or Memory mode. (p. 23)
- ② Push [MENU]  [C].
 - Enters the MENU mode.
- ③ Rotate [DIAL]Ⓢ to select "HOMECH" (Home channel).

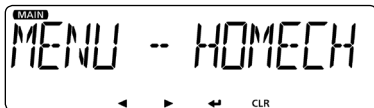

- ④ Push [↵]Ⓢ.
 - Goes to the next tree level.
- ⑤ Rotate [DIAL]Ⓢ to select "SET.FRQ" (Frequency setting) or "SET CH" (Channel setting).

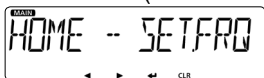

Frequency setting

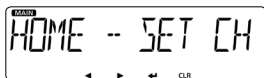

Channel setting

- ⑥ Push [↵]Ⓢ.

- Beeps sound
- Sets the Home channel, and exits the MENU mode.

◇ Home channel operation

After setting the Home channel, rotate [DIAL]Ⓢ in the VFO or Memory mode.

When the Home channel is selected, a beep sounds.

For your reference:

- When you push [HOME CALL] on the supplied HM-207, you can select the Home channel.
- You can turn OFF the Home Channel Beep function in the "HOME B" (Home channel beep) item of EXMENU. (p. 16)

For your reference:

You can clear the Home channel setting.

- Rotate [DIAL]Ⓢ to select "Clear" in step ⑤ as shown to the left, and then push [↵]Ⓢ.

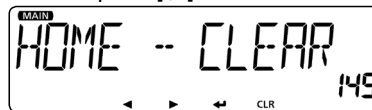

■ Using the DTMF Memory

The transceiver can store up to 16 Memory channels of 24 digit DTMF codes.

- “E” stands for “*” and “F” stands for “#” on the display.

◇ Entering a DTMF code

- ① Hold down [LOW DTMF] **C** for 1 second.
 - Enters the DTMF Menu mode.
- ② Rotate [DIAL] **S** to select “MEMORY” (DTMF Memory).

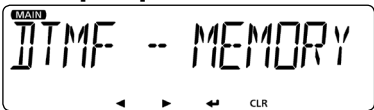

- ③ Push [↵] **D**.
 - Displays the DTMF Memory Selection screen.
- ④ Rotate [DIAL] **S** to select a desired DTMF memory.

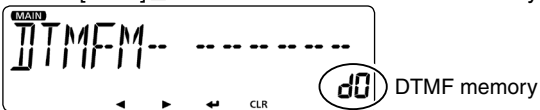

- ⑤ Push [↵] **D**.
 - Enters the DTMF Memory Entry mode.

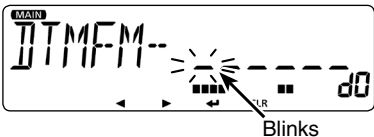

- ⑥ Rotate [DIAL] **S** to select a desired number to enter a code.

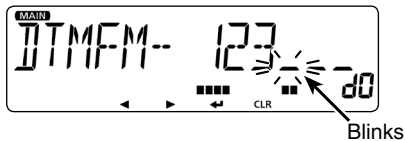

- ⑦ Push [◀] **D** to move the cursor backwards, or push [▶] **D** to move the cursor forwards.
 - Push [CLR] **D** to delete the selected code and all codes that are located to the right of the cursor.
 - When the cursor is located to the right edge, the code to the left of the cursor is deleted.
 - Hold down [CLR] **D** for 1 second to delete all the code.
- ⑧ Repeat steps ⑥ and ⑦ to enter a desired DTMF code.
- ⑨ After entering, push [↵] **D**.
 - Beeps sound.
 - Saves the channel, and returns to the DTMF memory selection screen.
- ⑩ Push [MAIN BAND] **S**.
 - Exits the DTMF Menu mode.

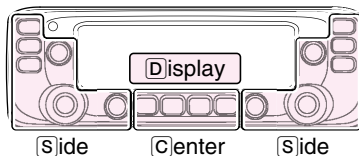

The **C**, **S**, or **D** in the instructions indicate the area of the controller.

- C**: Center
- S**: Side
- D**: Display

■ Transmitting DTMF code

◇ Transmitting DTMF code (DTMF Memory)

- ① Hold down [LOW DTMF]**[C]** for 1 second.
 - Enters the DTMF Menu mode.
- ② Rotate [DIAL]**[S]** to select “TX” (DTMF Transmit).

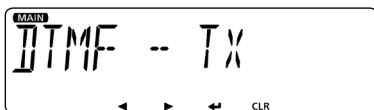

- ③ Push [**↵**]**[D]**.
 - Displays the DTMF Memory Selection screen.
- ④ Rotate [DIAL]**[S]** to select a desired DTMF Memory channel.

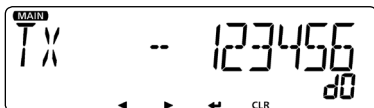

- ⑤ Push [**↵**]**[D]**.
 - Transmits the selected DTMF code, and exits the DTMF Menu mode.

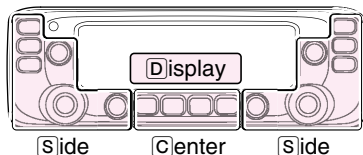

The **[C]**, **[S]**, or **[D]** in the instructions indicate the area of the controller.

[C]: Center

[S]: Side

[D]: Display

◇ Transmitting DTMF code (Direct Input)

- ① Hold down [LOW DTMF]**[C]** for 1 second.
 - Enters the DTMF Menu mode.
- ② Rotate [DIAL]**[S]** to select “TX” (DTMF Transmit).

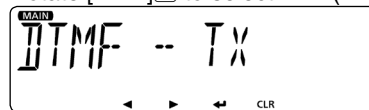

- ③ Push [**↵**]**[D]**.
 - Displays the DTMF Memory Selection screen.
- ④ Rotate [DIAL]**[S]** to select “DIRECT” (DTMF Direct input).

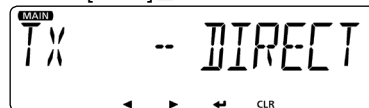

- ⑤ Push [**↵**]**[D]**.
 - Enters the DTMF Code Entry mode.
- ⑥ Enter a desired DTMF code as described on page 54.
- ⑦ After entering, push [**↵**]**[D]**.
 - Transmits the entered DTMF code, and exits the DTMF Menu mode.

For your reference:

- While transmitting, push [LOW DTMF]**[C]** to cancel the transmission.
- You can directly transmit a DTMF code by pushing a 10-keypad key on the HM-207 while holding down [PTT].

◇ Selecting the DTMF transmit speed

You can select the DTMF transmit speed.

- ① Hold down [LOW DTMF] [C] for 1 second.
 - Enters the DTMF Menu mode.
- ② Rotate [DIAL] [S] to select “SPEED” (DTMF Speed).
- ③ Push [↵] [D].
 - Displays the DTMF Speed Setting screen.
- ④ Rotate [DIAL] [S] to select a desired transmit speed.
 - 100: Transmits the DTMF tones at about 100 milliseconds per code.
5 characters per second.
 - 200: Transmits the DTMF tones at about 200 milliseconds per code.
2.5 characters per second.
 - 300: Transmits the DTMF tones at about 300 milliseconds per code.
1.6 characters per second.
 - 500: Transmits the DTMF tones at about 500 milliseconds per code.
1 character per second.
- ⑤ Push [MAIN BAND].
 - Exits the DTMF Menu mode.

■ Tone Squelch function

The squelch opens only when you receive a signal containing a matching subaudible tone in the FM or FM narrow mode. You can silently wait for calls from others using the same tone. Also, the reversed Tone Squelch function will mute the squelch when a signal containing a matched subaudible tone. You can set different tone frequencies or codes between transmission and reception.

◇ Operation

1. Setting the Tone function

- ① Push [MENU] [M] [C].
 - Enters the MENU mode.
- ② Rotate [DIAL] [S] to select “TONE” (Tone).

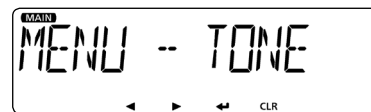

- ③ Push [↵] [D].
 - Goes to the next tree level.
- ④ Rotate [DIAL] [S] to select a desired tone squelch type.
 - Selectable options are listed on the next page.
 - To use the Tone Squelch function, select other than “OFF,” “TONE,” or “DTC.OFF.”

Continued on the next page.

8 OTHER FUNCTIONS

■ Tone Squelch function (Continued)

- OFF: The Tone Squelch function is OFF.
- TONE: Enables the subaudible tone encoder.
- TSQL (“**t••**” appears):
Enables the tone squelch with the Pocket Beep function.
- TSQL: Enables the Tone Squelch function.
- DTCS (“**t••**” appears):
Enables the DTCS squelch with the Pocket Beep function.
- DTCS: Enables the DTCS Squelch function.
- TSQL-R: Enables the Reverse Tone Squelch function.
- DTCS-R: Enables the Reverse DTCS Squelch function.
- DTC.OFF: When you transmit, the selected DTCS code is superimposed on your normal signal.
When you receive, the function is OFF.
- TON.DTC: When you transmit, the selected subaudible tone is superimposed on your normal signal.
When you receive, the DTCS squelch opens only for a signal that includes a matching DTCS code and polarity. (Audio is heard).
- DTC.TSQ: When you transmit, the selected DTCS code is superimposed on your normal signal.
When you receive, the tone squelch opens only for a signal that includes a matching tone frequency. (Audio is heard)
- TON.TSQ: When you transmit, the selected subaudible tone is superimposed on your normal signal.
When you receive, the tone squelch opens only for a signal that includes a matching tone frequency. (Audio is heard)

⑤ Push [**←J**]D.

- Sets the selected option, and goes back to the previous tree level.

⑥ Push [MAIN BAND]S.

- Exits the MENU mode.
- Sets a desired tone frequency or DTCS code. (p. 19)

2. Transmitting

Hold down [PTT] to call a desired station, and operate normally.

◇ Setting the Tone frequency

- ① Push [MENU] [C].
 - Enters the MENU mode.
- ② Rotate [DIAL] [S] to select “C TONE” (TSQL Freq).

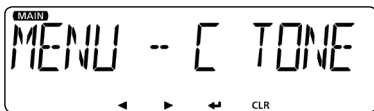

- ③ Push [J] [D].
 - Goes to the next tree level.
- ④ Rotate [DIAL] [S] to select a desired tone frequency.

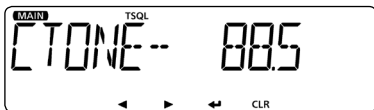

Selectable options: 67.0 Hz to 254.1 Hz

- ⑤ Push [J] [D].
 - Sets the selected option, and goes back to the previous tree level.
- ⑥ Push [MAIN BAND] [S].
 - Exits the MENU mode.

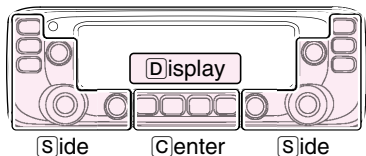

The [C], [S], or [D] in the instructions indicate the area of the controller.

[C]: Center

[S]: Side

[D]: Display

◇ Setting the Repeater Tone frequency

- ① Push [MENU] [C].
 - Enters the MENU mode.
- ② Rotate [DIAL] [S] to select “R TONE” (Repeater Tone).

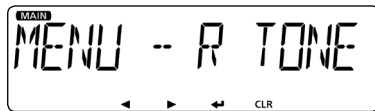

- ③ Push [J] [D].
 - Goes to the next tree level.
- ④ Rotate [DIAL] [S] to select a desired tone frequency.

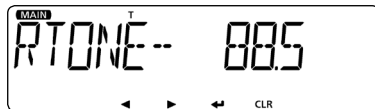

Selectable options: 67.0 Hz to 254.1 Hz

- ⑤ Push [J] [D].
 - Sets the selected option, and goes back to the previous tree level.
- ⑥ Push [MAIN BAND] [S].
 - Exits the MENU mode.

8 OTHER FUNCTIONS

■ Tone Squelch function (Continued)

◇ Setting the DTCS code

- ① Push [MENU] [C].
 - Enters the MENU mode.
- ② Rotate [DIAL] [S] to select “CODE” (DTCS Code).

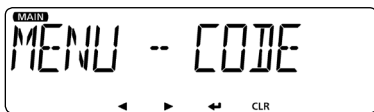

- ③ Push [↵] [D].
 - Goes to the next tree level.
- ④ Rotate [DIAL] [S] to select a desired tone code.

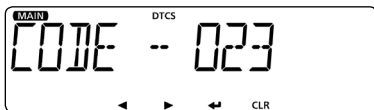

Selectable options: 023 to 754

- ⑤ Push [↵] [D].
 - Sets the selected option, and goes back to the previous tree level.
- ⑥ Push [MAIN BAND] [S].
 - Exits the MENU mode.

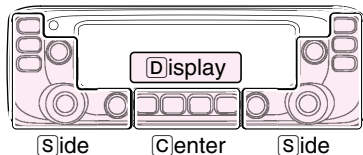

The [C], [S], or [D] in the instructions indicate the area of the controller.

[C]: Center

[S]: Side

[D]: Display

◇ Setting the DTCS polarity

- ① Push [MENU] [C].
 - Enters the MENU mode.
- ② Rotate [DIAL] [S] to select “DTCS-P” (DTCS Polarity).

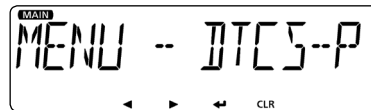

- ③ Push [↵] [D].
 - Goes to the next tree level.
- ④ Rotate [DIAL] [S] to select a desired DTCS polarity.



Selectable options:

- BOTH N: TX and RX polarity are Normal.
 - TN-RR: TX polarity is Normal, RX polarity is Reverse.
 - TR-RN: TX polarity is Reverse, RX polarity is Normal.
 - BOTH R: TX and RX polarity are Reverse.
- ⑤ Push [↵] [D].
 - Sets the selected option, and goes back to the previous tree level.
 - ⑥ Push [MAIN BAND] [S].
 - Exits the MENU mode.

■ Weather channel operation (USA version only)

There are 10 weather channels to listen to the NOAA (National Oceanographic and Atmospheric Administration) weather broadcasts.

◇ Weather channel selection

- In the Memory mode, push [MR CALL][S] to select the Weather channel mode.
 - Displays the selected weather channel (“WX-01” to “WX-10”).

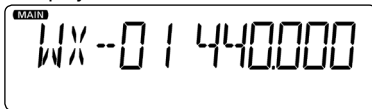

- Rotate [DIAL][S] to select a desired weather channel.

◇ Weather alert function

A NOAA (National Oceanographic and Atmospheric Administration) broadcast station transmits a weather alert tone before any important weather information.

This function detects the weather alert tone on weather channels. When an alert signal is detected, “WX” and “ALT” are alternately displayed, and a beep sounds until you change the operating mode or weather channel, turn OFF the Weather Alert function, or turn OFF the transceiver.

The previously selected (used) weather channel is checked periodically during standby, or while scanning.

- Push [MENU][C].
 - Enters the MENU mode.
- Rotate [DIAL][S] to select “WX-ALT” (Weather alert).

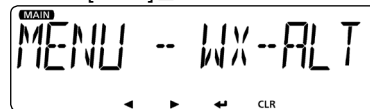

- Push [↵][D].
 - Goes to the next tree level.
- Rotate [DIAL][S] to select “ON.”
 - Turns ON the Weather Alert function.
- Push [↵][D].
 - Sets the selected option, and goes back to the previous tree level.
- Push [MAIN BAND][S].
 - Exits the MENU mode.
 - You can also select a scan or priority watch operation.
- Select the VFO, a Memory or Call channel to set the desired standby mode.

When an alert signal is detected



■ Cloning function

Cloning allows you to quickly and easily transfer the entered contents from a PC to a transceiver using the optional CS-2730 CLONING SOFTWARE, or enter contents from one transceiver to another one.

◇ Cloning from a PC using a cloning cable

You can clone with the CS-2730 CLONING SOFTWARE and the optional cloning cable.

See the CS-2730 instruction manual for details. (downloaded from the Icom WEB site, <http://www.icom.co.jp/world/>)

◇ Cloning between transceivers

1. Connecting the master and sub transceivers

Select a master transceiver to send data to a sub transceiver. Connect them as shown below.

- ① Turn OFF the master and sub transceivers.
- ② Connect the OPC-474 CLONING CABLE to the [SP2] jack of the master and sub transceivers.

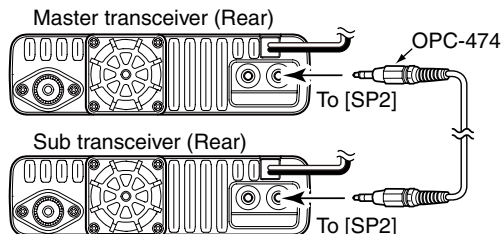

- ③ Turn ON the master and sub transceivers.

2. Setting the sub transceiver

- ④ Push [MENU] [C] of the sub transceiver.
 - Enters the MENU mode.
- ⑤ Rotate [DIAL] [S] to select "CLONE" (Clone).
(MENU-EXMENU > EXMEN-OTHERS > OTHER-CLONE)
- ⑥ Push [↵] [D].
 - Goes to the next tree level.
- ⑦ Rotate [DIAL] [S] to select "CLONE" (Clone Mode).
- ⑧ Push [↵] [D].
 - Displays "CLONE?."
- ⑨ Rotate [DIAL] [S] to select "YES."

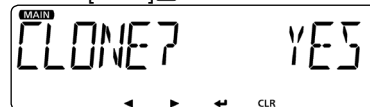

- ⑩ Push [↵] [D].
 - Enters the Clone mode.

3. Setting the master transceiver

- ① Push [MENU] [C] of the master transceiver.
 - Enters the MENU mode.
- ② Rotate [DIAL] [S] to select “CLONE” (Clone).
(MENU-EXMENU > EXMEN-OTHERS > OTHER-CLONE)
- ③ Push [J] [D].
 - Goes to the next tree level.
- ④ Rotate [DIAL] [S] to select “MASTER” (Clone master Mode).

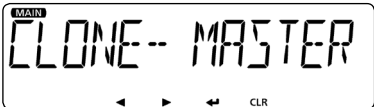

- ⑤ Push [J] [D].
 - Displays “MASTER?”
- ⑥ Rotate [DIAL] [S] to select “YES.”

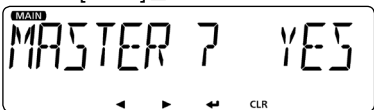

- ⑦ Push [J] [D].
 - Enters the Clone master mode.

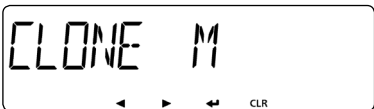

- ⑧ Push [J] [D].
 - Displays “CLONE OUT” on the master transceiver’s display.

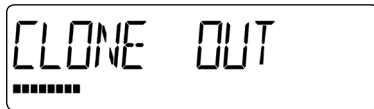

- Displays “CLONE IN” on the sub transceiver’s display.

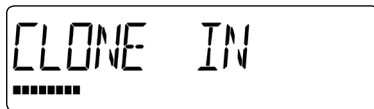

- ⑨ After the cloning is completed, returns to the Clone mode screen.
 - Turn OFF the sub transceiver, then ON to exit the cloning mode, and you can use the transceiver with the cloned content.
 - Turn OFF the master transceiver, then ON to exit the cloning mode.

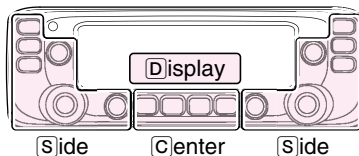

The [C], [S], or [D] in the instructions indicate the area of the controller.

- [C]: Center
- [S]: Side
- [D]: Display

■ Connecting the controller to the main unit

Connect the controller to the main unit with the supplied control cable.

• The following longer cables may be required, depending on the installation location.

OPC-440 MIC EXTENSION CABLE:	5 m (16.4 ft)
OPC-647 MIC EXTENSION CABLE:	2.5 m (8.2 ft)
OPC-1156 CONTROLLER EXTENSION CABLE:	3.5 m (11.4 ft)
SP-35 EXTERNAL SPEAKER:	2 m (6.5 ft)
SP-35L EXTERNAL SPEAKER:	6 m (19.6 ft)
SP-30 EXTERNAL SPEAKER:	2.8 m (9.1 ft)

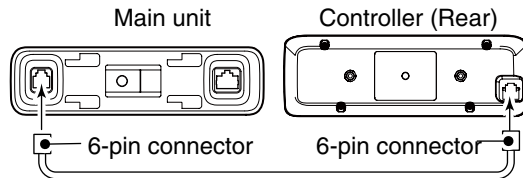

◇ **When using the MBA-4 COMBINATION BRACKET**
When using the MBA-4 COMBINATION BRACKET, you can unify the controller and the main unit.

- ① Unplug the 6-pin connector from the controller and the main unit.
- ② Attach the MBA-4 to the controller's rear panel with the supplied two screws (M2.6×6) as shown to the right.
- ③ Connect the supplied connector to the controller's rear panel as shown to the right.

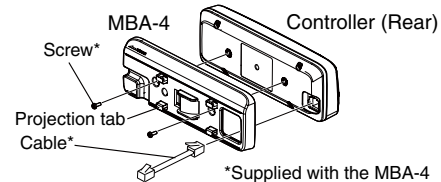

- ④ Connect the other side of connector to the main unit.
- ⑤ Insert the MBA-4's projection tabs into the main unit.
- ⑥ Slide the MBA-4 to the left.

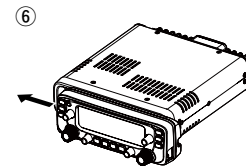
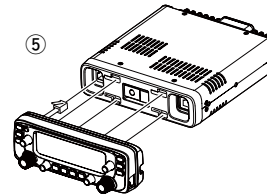

■ Connecting a microphone

Plug in the microphone to the microphone jack on the main unit or controller as shown below.

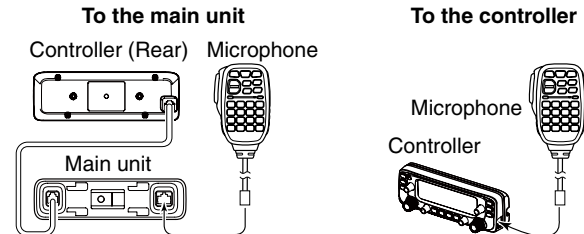

■ Connecting to a DC power supply

Connect to a 13.8 V DC power source with at least 15 A capacity.

Connect the black DC power cable to the (-) Negative terminal, and the red DC power cable to the (+) Positive terminal.

⚠ WARNING! NEVER remove the fuse holders from the DC power cable.

• CONNECTING TO A DC POWER SUPPLY

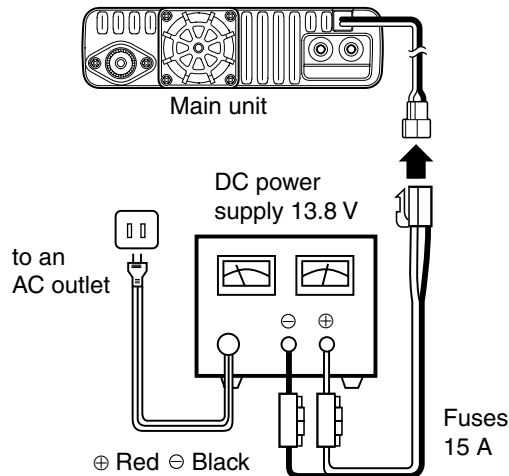

⚡ See page 69 for a car battery connection.

■ Installing the controller

◇ When installing into your vehicle

You can install the controller on the dashboard or the console of your vehicle with the optional MBA-5 CONTROLLER BRACKET and the MBF-1 MOUNTING BASE. (p. 66)

- ① Attach the MBF-1 on the dashboard or the console.
 - See the MBF-1 instruction manual for details.

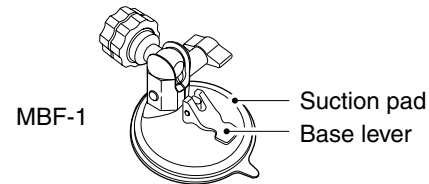

- ② Attach the MBA-5 to the controller's rear panel with the two supplied screws as shown below.

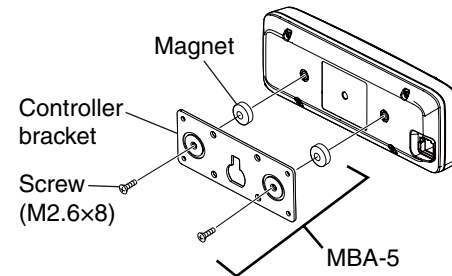

9 INSTALLATION AND CONNECTIONS

■ Installing the controller (Continued)

- ③ Slide the MBA-5's guide down over the MBF-1's locking head, as shown below.
 - Be sure the locking head fits into the slot at the top of the guide.
- ④ Tighten the lock knob to securely attach the Controller.
- ⑤ Adjust the viewing angle of the remote controller, then tighten the adjustment knob.

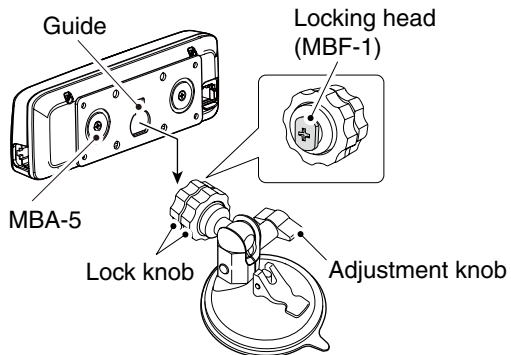

◇ Attaching to a flat surface

You can install the controller on a flat surface with the optional MBA-5*¹ CONTROLLER BRACKET.

When attaching the bracket to a wall, use a self-tapping screw*² (3 mm(d)).

*¹ MBA-5 may be supplied, depending on the transceiver version.

*² Purchase separately

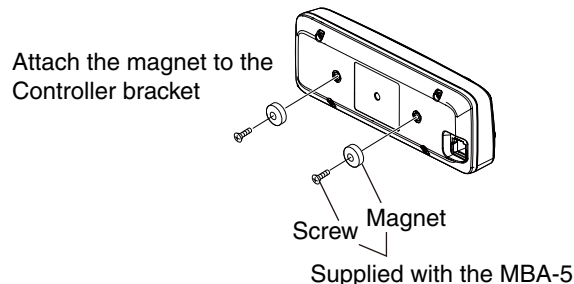

Attaching the bracket to a wall

Self-tapping screw (3 mm(d))
Purchase separately

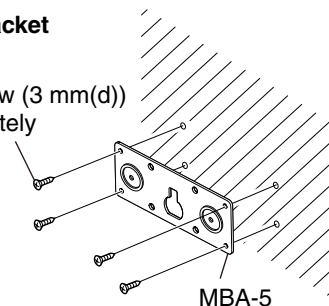

■ Installing in a vehicle

CAUTION: NEVER place the main unit or remote controller where normal operation of the vehicle may be hindered or where it could cause bodily injury.

CAUTION: NEVER place the main unit or remote controller where air bag deployment may be obstructed.

DO NOT place the transceiver or remote controller where hot or cold air blows directly onto it.

• Remote controller installation

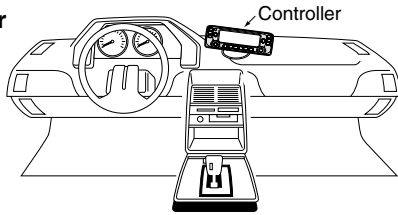

• Main unit installation

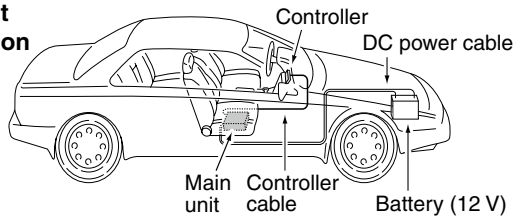

◇ Using the mounting bracket

You can install the main unit on the dashboard or the console of your vehicle with the optional MBF-4 MOBILE BRACKET.

- ① Drill 4 holes where the mounting bracket is to be installed.
 - Approximately 5.5 ~ 5.6 mm (0.21 ~ 0.22 inch)(d) when using nuts, approximately 2 ~ 3 mm (0.08 ~ 0.12 inch)(d) when using self-tapping screws.
- ② Insert the supplied screws, nuts and washers through the mounting bracket and tighten.
- ③ Adjust the angle to suit your needs.

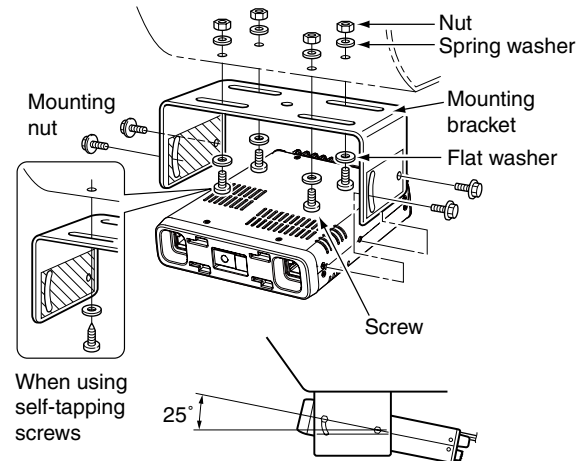

■ Installing an antenna

• Antenna location

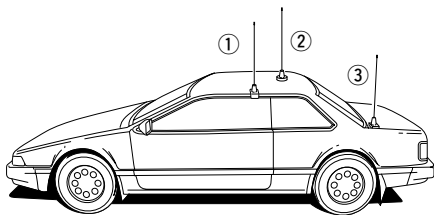

To obtain maximum performance from the transceiver, select a high-quality antenna and mount it in a good location.

- Connect the antenna to the antenna connector on the rear panel of the main unit.

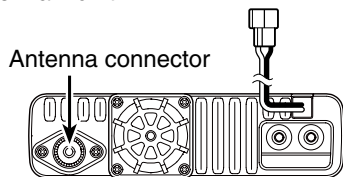

NOTE:

- Make the coaxial cable as short as possible.
- Be sure to seal the antenna connection.

◇ About Coaxial cable

For radio communications, the antenna is of critically importance, along with output power and receiver sensitivity. Select a well-matched 50 Ω antenna and coaxial cable feed-line. We recommend 1.5:1 or better Voltage Standing Wave Ratio (VSWR) on your operating bands.

◇ About the internal duplexer

The transceiver has an internal duplexer, and you can easily connect a dual band antenna.

If you separately connect the VHF and UHF antennas, use a separate duplexer.

When you connect the VHF and UHF antennas separately:

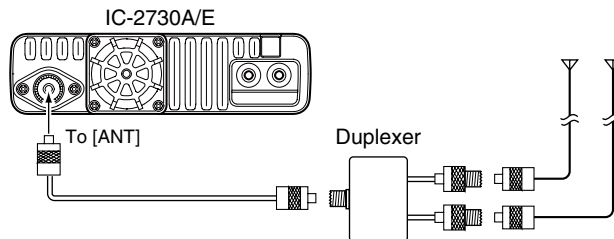

■ Connecting to a battery

⚠ WARNING!

- **NEVER** remove the fuses from the cable connecting the transceiver to a power source, especially a car battery.
- **NEVER** connect the transceiver directly to a 24 V battery.

The transceiver may not receive well on some frequencies when installed in a hybrid vehicle, or any type of electric vehicle (fuel cell vehicle). This is because vehicle's electric components, such as the inverter system, generate a lot of electrical noise.

- **DO NOT** use a cigarette lighter socket as a power source when operating in a vehicle. The plug may cause voltage drops and ignition noise may be superimposed onto transmit or receive audio.
- Use a rubber grommet when passing the DC power cable through a metal plate to prevent a short circuit.

⚠ WARNING!

- Make sure DC power cable polarity is correct.
Red: Positive + terminal
Black: Negative – terminal
- **DO NOT** pull or bend the DC power cable.

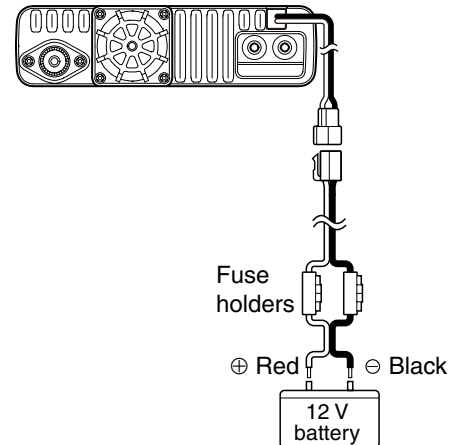

9 INSTALLATION AND CONNECTIONS

■ Connecting to a battery (Continued)

CONNECTING TO A VEHICLE BATTERY

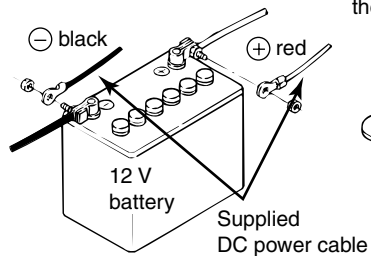
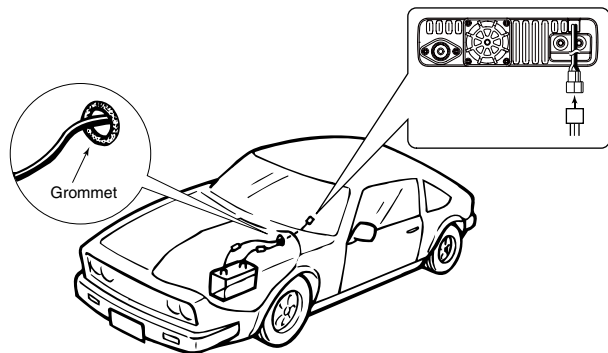

NOTE: Use terminals for the cable connections.

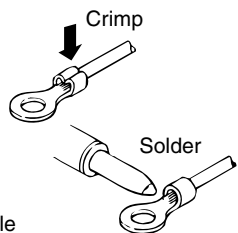

- **HM-154** HAND MICROPHONE
- **HM-207** REMOTE-CONTROL MICROPHONE
- **HM-209** ACTIVE NOISE CANCELING MICROPHONE
- **SP-30** EXTERNAL SPEAKER
Cable length: 2.8 m (9.1 ft)
- **SP-35/SP-35L** EXTERNAL SPEAKER
Used for mobile operation
Cable length
SP-35 : 2 m (6.5 ft)
SP-35L : 6 m (19.7 ft)
- **MBF-1** MOUNTING BASE
Used for installing the MBA-5
- **MBF-4** MOBILE BRACKET
- **MBA-4** COMBINATION BRACKET
- **MBA-5** CONTROLLER BRACKET
- **OPC-589** MIC ADAPTOR CABLE
Allows you to connect an 8-pin plug microphone.
- **OPC-837** CONTROLLER CABLE
Cable length: 3.5 m (11.4 ft)
- **OPC-440** MIC EXTENSION CABLE
Cable length: 5.0 m (16.4 ft)
- **OPC-647** MIC EXTENSION CABLE
Cable length: 2.5 m (8.2 ft)
- **CS-2730** CLONING SOFTWARE
Free download software
- **OPC-474** CLONING CABLE
Allows data cloning between transceivers.
- **OPC-478UC** CLONING CABLE
Allows data cloning with CS-2730.
- **OPC-1156** CONTROLLER EXTENSION CABLE
Cable length: 3.5 m (11.4 ft)
- **UT-133/UT-133A** Bluetooth® UNIT
- **VS-3** Bluetooth® HEADSET

11 Bluetooth® OPERATION

■ Operating Bluetooth®

When you install the optional UT-133/A Bluetooth® UNIT in the transceiver, you can connect to an optional VS-3 Bluetooth® HEADSET.

In this section, the IC-2730A/E with the UT-133/A is described as simply “transceiver.”

When you connect the VS-3 to the transceiver, you can wirelessly transmit and receive the headset audio.

The VS-3 has a [PTT] switch, so you can transmit in the same way as using the transceiver’s [PTT] switch.

The VOX function can also be used, so you can toggle transmit and receive by your voice through the headset.

You can assign a desired key function to the keys on the side panel of the VS-3 to remotely operate the transceiver.

Communication range of Bluetooth® is approximately 10 meters (32.8 ft).

The Bluetooth® communication range may vary, depending on the environment in which the device operates. Microwave ovens or Wireless LANs may cause interference. In that case, stop using those devices or move away from them. The Bluetooth® headset has a range of use. If the communication is unstable, use the device within the range.

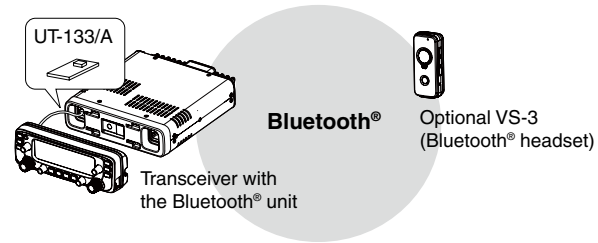

■ Electromagnetic Interference

When you use a Bluetooth® device, pay attention to the following:

Bluetooth® devices operate on the 2.4 GHz band.

The 2.4 GHz band is also used by other devices, such as Wireless LAN products, microwave ovens, RFID systems, amateur radio stations, and so on.

When using the Bluetooth® device near such devices, interference may occur, causing a decrease in communication speed, and an unstable connection.

In such cases, use this device away from the other devices, or stop using those devices.

■ Installing the UT-133/UT-133A

When you install the optional UT-133/A Bluetooth® UNIT in the transceiver, you can communicate with other Bluetooth® headset.

NOTE: Before touching the transceiver or UT-133/A, remove static electricity from your body by touching a grounded object such as a grounded piece of equipment. The static electricity from your body may damage the transceiver or the UT-133/A, or cause data lost.

⚠ WARNING! BE SURE TO disconnect the DC power cable before starting the following procedures.

- ① Turn the transceiver upside-down.
- ② Remove the three screws from the bottom of the transceiver and the four screws from the sides, then lift off the bottom cover.

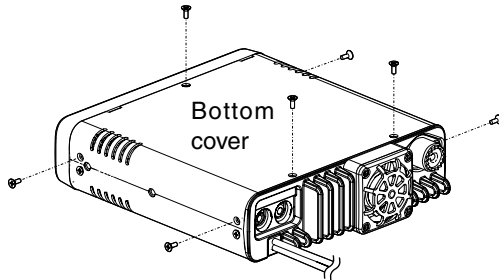

- ③ Place one end the UT-133/A under the edge of the front panel, with the connector facing down.

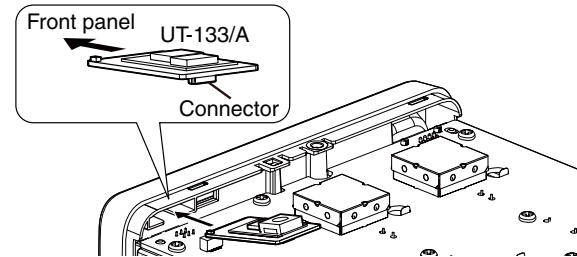

- ④ Carefully, push the connector into the socket.
 - Ensure the UT-133/A is installed correctly.

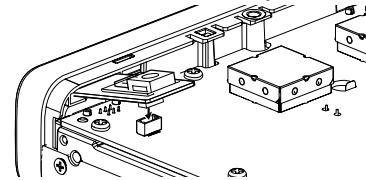

- ⑤ Reattach the bottom cover and screws.

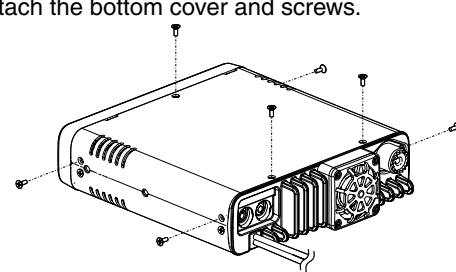

11 Bluetooth® OPERATION

■ Pairing with a headset

This section describes how to pair with a Bluetooth® headset.

1. Turning ON Bluetooth® of the transceiver

- ① Push [MENU] [C].
 - Enters the MENU mode.
- ② Rotate [DIAL] [S] to select “BT” (Bluetooth®).
(MENU-EXMENU > EXMEN-BT SET > BTSET-BT)
- ③ Push [↵] [D].
 - Goes to the next tree level.
- ④ Rotate [DIAL] [S] to select “ON.”
- ⑤ Push [↵] [D].

2. Entering the pairing mode of the VS-3

- See the VS-3’s instruction manual for details.

3. Entering the pairing mode of the transceiver

- ⑥ Rotate [DIAL] [S] to select “PAIR” (Paring).
(MENU-EXMENU > EXMEN-BT SET > BTSET-PAIR)
- ⑦ Push [↵] [D].
 - “PAIRING” blinks, and pairing starts.
 - While connecting, “CONNECTING” blinks.
 - After the connecting to the headset, “CONNECTED” is displayed.
- ⑧ Push [MAIN BAND] [S].
 - Exits the MENU mode.
 - Displays the Bluetooth® icon while connected to a Bluetooth® headset.

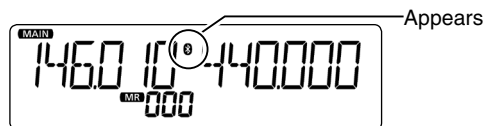

For your reference:

When the transceiver cannot find any available headset, and “FAILED” is displayed on the display, push [↵] [D] to search again for a headset.

For your reference:

The “AT CON” (Auto Connect) item is set to ON as the default, so the transceiver automatically connects to the paired headset when the headset power is ON. (p. 16)

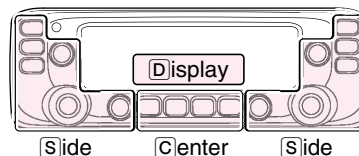

The [C], [S], or [D] in the instructions indicate the area of the controller.

[C]: Center

[S]: Side

[D]: Display





■ VOX function

The VOX (Voice-Operated Transmission) function toggles the transceiver between transmit and receive by your voice. This function provides hands-free operation.

If the transceiver does not connect to a Bluetooth® headset, you cannot use the VOX function, even if the “VOX” item is set to ON.

You can use the VOX function with the optional VS-3 Bluetooth® headset.



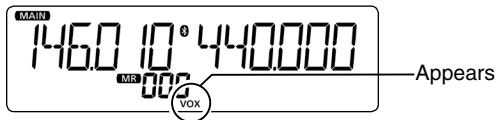

◇ Using the VOX function

- ① Push [MENU]  [C].
 - Enters the MENU mode.
- ② Rotate [DIAL]  to select “VOX” (VOX).
(MENU-EXMENU > EXMEN-BT SET > BTSET-HS SET > HSSET-VOX > VOX-VOX)
- ③ Push [] [D].
 - Goes to the next tree level.
- ④ Rotate [DIAL]  to select “ON.”
- ⑤ Push [MAIN BAND] .
 - Exits the MENU mode.



◇ Setting the VOX level

NOTE: We recommend you set the “MIC G” (MIC gain) item in EXMENU or the headset’s microphone gain level, before setting the “VOX LV” (VOX level) item in EXMENU,

- ① Push [MENU]  [C].
 - Enters the MENU mode.
- ② Rotate [DIAL]  to select “VOX LV” (VOX level).
(MENU-EXMENU > EXMEN-BT SET > BTSET-HS SET > HSSET-VOX > VOX-VOX LV)
- ③ Push [] [D].
 - Goes to the next tree level.
- ④ While speaking into the headset microphone, rotate [DIAL]  to adjust the VOX level.
 - Higher values make the VOX function more sensitive to your voice.
 - Displays “VOX” when the TX level audio is input. In this case, the transceiver does not transmit.
- ⑤ Push [MAIN BAND] .
 - Exits the MENU mode.

- ▨ If the VOX operation is intermittent, set the “VOX.DLY” (VOX delay) item in EXMENU to an more stable value. (p. 17)
- ▨ When the VOX function is ON, you can also adjust the VOX level by rotating [DIAL]  while transmitting.

11 Bluetooth® OPERATION

■ VOX function (Continued)

◇ VOX-related settings

You can set the “VOX.DLY” (VOX delay) and “VOX.TOT” (VOX Time-out timer) items in EXMENU. (p. 17)

• VOX Delay “VOX.DLY”

The VOX delay is the amount of time the transmitter stays ON after you stop speaking. It allows for normal pauses in speaking.

• VOX Time-Out Timer “VOX.TOT”

The VOX Time-Out Timer prevents accidental prolonged transmission.

NOTE: While receiving a signal or sounding a beep, the transceiver does not switch to transmit, even if you speak.

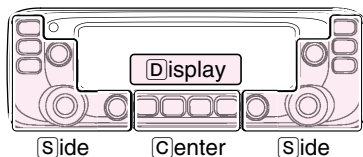

The **C**, **S**, or **D** in the instructions indicate the area of the controller.

C: Center

S: Side

D: Display

■ Other headset settings

◇ AF Output

If the “AF OUT” (AF output) item is set to “HS+SP” (Headset & Speaker), you can hear audio from both a connected Bluetooth® headset and the transceiver’s speaker.

- ① Push [MENU] **C**.
 - Enters the MENU mode.
- ② Rotate [DIAL] **S** to select “AF OUT” (AF output).
(MENU-EXMENU > EXMEN-BT SET > BTSET-HS SET > HSSET-AF OUT)
- ③ Push [↵] **D**.
 - Goes to the next tree level.
- ④ Rotate [DIAL] **S** to select “HS+SP.”
- ⑤ Push [MAIN BAND] **S**.
 - Exits the MENU mode.
 - Audio is heard from both the connected Bluetooth® headset and the transceiver’s speaker.

◇ About the VS-3 headset

You can set the detailed settings of the optional VS-3 Bluetooth® HEADSET. Also, you can assign a desired key function to VS-3's [PLAY], [FWD] and [RWD] in the "CUST K" (Custom key) item of EXMENU.

• Power Save "PoSAVE"

The Power Save function temporarily disconnects the Bluetooth® connection if no communication or operation is performed for 120 seconds to prolong the VS-3's battery.

▨ The Power Save function is disabled when the VOX function is ON. (p. 74)

• One-Touch PTT "PTT" (p. 17)

The One-Touch PTT function enables you to toggle transmit and receive by pushing [PTT].

• PTT Beep "PTT B" (p. 17)

Set a beep to sound when you push [PTT] on the VS-3. This setting is different from the transceiver's beep setting. When both settings are set to "ON," the beeps sound on the transceiver and the headset.

• Custom Key Beep "CUST B" (p. 17)

Set a beep to sound when you push [PLAY], [FWD] or [RWD] on the VS-3.

This setting is different from the transceiver's beep setting. When both settings are set to "ON," the beeps sound on the transceiver and the headset.

• Custom key "CUST K" (p. 17)

You can assign desired key functions to [PLAY], [FWD] and [RWD] on the VS-3.

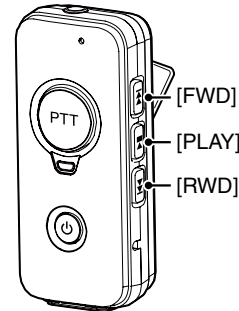

Optional VS-3
(Bluetooth® headset)

11 Bluetooth® OPERATION

■ The maximum number of paired headsets

Up to seven Bluetooth® headsets can be paired with the UT-133/A Bluetooth® UNIT.

■ Disconnecting from a headset

You can disconnect from a headset without cancelling the pairing.

- ① Push [MENU] [C].
 - Enters the MENU mode.
- ② Rotate [DIAL] [S] to select “DISCON” (Disconnection).
(MENU-EXMENU > EXMEN-BT SET > BTSET-DISCON)
- ③ Push [↵] [D].
 - “DISCONNECT” blinks.
- ④ Push [MAIN BAND] [S].
 - Exits the MENU mode.

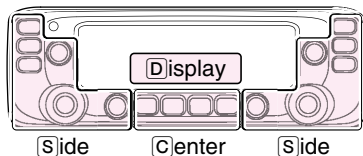

The [C], [S], or [D] in the instructions indicate the area of the controller.

[C]: Center

[S]: Side

[D]: Display

■ Deleting a headset from the pairing list

You can delete a Bluetooth® headset from the pairing list. Before deleting a connected headset, disconnect it.

- ① Push [MENU] [C].
 - Enters the MENU mode.
- ② Rotate [DIAL] [S] to select “CONNEX” (Connection).
(MENU-EXMENU > EXMEN-BT SET > BTSET-CONNEX)
- ③ Push [↵] [D].
- ④ Rotate [DIAL] [S] to select a headset to delete.
- ⑤ Push [CLR] [D].
 - Displays “DELETE?.”
- ⑥ Rotate [DIAL] [S] to select “YES.”
- ⑦ Push [↵] [D].
 - Deletes the selected headset from the pairing list.
- ⑧ Push [MAIN BAND] [S].
 - Exits the MENU mode.

■ Resetting the installed Bluetooth® unit

You can reset the installed UT-133/A Bluetooth® UNIT. You should reset the unit if you have trouble during Bluetooth® operation. When you do a Partial reset or All reset, the Bluetooth® settings returns to their factory defaults. However, the headset name and pairing/connection information remain.

- ① Push [MENU] [OK] [C].
 - Enters the MENU mode.
- ② Rotate [DIAL] [S] to select "INITBT" (Initialize).
(MENU-**EXMENU** > EXMEN-**BT SET** > BTSET-**INITBT**)
- ③ Push [↵] [D].
 - Displays "INITBT?."
- ④ Rotate [DIAL] [S] to select "YES."
- ⑤ Push [↵] [D].
 - Resets the installed UT-133/A Bluetooth® UNIT's settings to their factory defaults, and returns to the standby display.

12 SPECIFICATIONS

◇ General

- Frequency coverage:

EUR	RX	118 ~ 174 MHz* ¹ , 375 ~ 550 MHz* ²
	TX	144 ~ 146 MHz, 430 ~ 440 MHz
ITR	RX	118 ~ 136.99166 MHz* ³ , 144 ~ 146 MHz, 430 ~ 434 MHz, 435 ~ 438 MHz
	TX	144 ~ 146 MHz, 430 ~ 434 MHz, 435 ~ 438 MHz
TPE	RX	144 ~ 146 MHz, 430 ~ 432 MHz
	TX	144 ~ 146 MHz, 430 ~ 432 MHz
USA	RX	118 ~ 174 MHz* ⁴ , 375 ~ 550 MHz* ⁵
	TX	144 ~ 148 MHz, 430 ~ 450 MHz* ⁵
KOR	RX	144 ~ 146 MHz, 430 ~ 440 MHz
	TX	144 ~ 146 MHz, 430 ~ 440 MHz
EXP	RX	118 ~ 174 MHz* ⁴ , 375 ~ 550 MHz* ²
	TX	137 ~ 174 MHz* ⁴ , 400 ~ 470 MHz* ²
CHN	RX	118 ~ 174 MHz* ¹ , 375 ~ 550 MHz* ²
	TX	137 ~ 174 MHz* ¹ , 400 ~ 470 MHz* ²

*1 Guaranteed only 144 ~ 146 MHz

*2 Guaranteed only 430 ~ 440 MHz

*3 Not guaranteed

*4 Guaranteed only 144 ~ 148 MHz

*5 Guaranteed only 430 ~ 450 MHz

- Mode: F2D/F3E (FM/FM-N), A3E (AM/AM-N) RX only
- No. of memory channels: 1000 channels
- No. of program scan channels: 25 channels (2 edge frequencies in each channel)
- No. of call channels: 2 channels
- Antenna connector: SO-239

- Antenna impedance: 50 Ω
- Usable temperature range: -10°C ~ +60°C, +14°F ~ +140°F
- Frequency stability: ±2.5 ppm (-10°C ~ +60°C, +14°F ~ +140°)
- Frequency resolution: 5 kHz, 6.25 kHz, 8.33 kHz, 10 kHz, 12.5 kHz, 15 kHz, 20 kHz, 25 kHz, 30 kHz, 50 kHz
The 8.33 kHz step is not selectable, depending on the operating band or mode.
- Power supply: 13.8 V DC ±15% (negative ground)
- Current drain:
 - Transmit
 - Maximum current drain: ≤ 10.5 A (TPE version)
≤ 13.0 A (Other versions)
 - Receive
 - Standby: ≤ 1.2 A
 - Maximum audio: ≤ 1.8 A
- Dimensions (projections not included):
 - Main unit: 150 (W) × 40 (H) × 151 (D) mm,
5.9 (W) × 1.6 (H) × 5.94 (D) inch
 - Controller: 150 (W) × 50 (H) × 27.2 (D) mm,
5.91 (W) × 1.97 (H) × 1.07 (D) inch
- Weight (approximate):
 - Main unit: 1.2 kg, 2.6 lb
 - Controller: 140 g, 4.9 oz

◇ **Transmitter**

- Modulation system:
 - FM/FM-N: Variable reactance frequency modulation
- Max Deviation:
 - FM: $\leq \pm 5.0$ kHz
 - FM-N: $\leq \pm 2.5$ kHz
- Microphone impedance: 600 Ω
- Spurious emission: ≤ -60 dBc
- Output power:
 - High 25 W, Mid 15 W, Low 5 W (TPE version)
 - High 50 W, Mid 15 W, Low 5 W (Other versions)

◇ **Receiver**

- Receive system: Double superheterodyne system
- IF frequencies:
 - A band 1st IF 38.85 MHz
 - 2nd IF 450 kHz
 - B band 1st IF 46.35 MHz
 - 2nd IF 450 kHz
- Sensitivity (except spurious points)
 - Amateur bands
 - FM/FM-N (12 dB SINAD) ≤ 0.18 μ V
 - Except Amateur bands
 - FM/FM-N (12 dB SINAD)
 - ≤ 0.32 μ V (137.000 ~ 159.995 MHz)
 - ≤ 0.56 μ V (160.000 ~ 174.000 MHz)
 - ≤ 0.56 μ V (375.000 ~ 399.995 MHz)
 - ≤ 0.32 μ V (400.000 ~ 499.995 MHz)
 - ≤ 0.56 μ V (500.000 ~ 550.000 MHz)
 - AM (10 dB S/N)
 - ≤ 1 μ V (118.000 ~ 136.99166 MHz)
- Squelch sensitivity: ≤ 0.13 μ V (Threshold)
- Selectivity:
 - FM ≥ 60 dB
 - FM-N ≥ 55 dB
- Spurious and image rejection ratio:
 - ≥ 60 dB
 - ≥ 55 dB (A band UHF)
- AF output power: ≥ 2.0 W (at 10% distortion with an 8 Ω load)
- AF output impedance: 8 Ω

13 MAINTENANCE

■ Resetting

Occasionally, erroneous information will be displayed when, for example, first applying power. This may be caused externally by static electricity or by other factors.

If this problem occurs, turn OFF power.

After waiting a few seconds, turn ON power again. If the problem is still there, perform a Partial reset or an All reset.

◇ Partial Reset

A Partial reset resets the operating settings to their default values (VFO frequency, VFO settings, MENU contents) without clearing the items below:

- Memory channel contents
- Scan Edge contents
- Call channel contents
- DTMF memory contents

- ① Push [MENU] [C].
 - Enters the MENU mode.
- ② Rotate [DIAL] [S] to select "PART" (Partial reset).
(MENU-EXMENU > EXMEN-OTHERS > OTHER-RESET > RESET-PART)

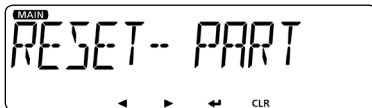

- ③ Push [↵] [D].
 - Displays "RESET?"
- ④ Rotate [DIAL] [S] to select "YES."
- ⑤ Push [↵] [D].
 - The transceiver displays "PART RESET," then the partial reset is completed.

◇ All Reset

BE CAREFUL! An All reset clears all programming and returns all settings to their factory defaults. See the Full Manual for details.

- ① Push [MENU] [C].
 - Enters the MENU mode.
- ② Rotate [DIAL] [S] to select "ALL" (All reset).
(MENU-EXMENU > EXMEN-OTHERS > OTHER-RESET > RESET-ALL)

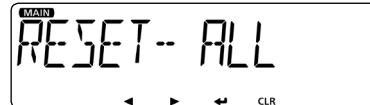

- ③ Push [↵] [D].
 - Displays "RESET?"
- ④ Rotate [DIAL] [S] to select "YES."
- ⑤ Push [↵] [D].
 - The transceiver displays "ALL RESET," then the all reset is completed.

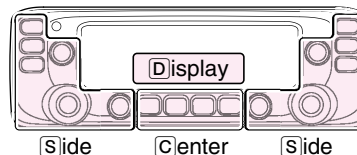

The [C], [S], or [D] in the instructions indicate the area of the controller.

- [C]: Center
- [S]: Side
- [D]: Display

■ Power protect function

The transceiver is equipped with a protection circuit for the power amplifier. The circuit activates when the transceiver continuously transmits at high power, and then the temperature becomes extremely high.

In this case, the transceiver automatically reduces transmit output power to low (approximate 5 W).

When the Power protect function activates, wait until the transceiver's temperature returns to normal.

NOTE: When the power supply voltage is over 17.0 V, the transceiver automatically displays "OVER V," and then sounds a warning beep. In this case, the transceiver may be damaged. If damage occurs, contact your nearest Icom Dealer or Service Center.

■ Spurious signals

Spurious signals may occur at some frequencies. These are created in the internal circuit and does not indicate a transceiver malfunction.

You may avoid the spurious signals with the IF exchange function. (p. 15)

■ Fuse replacement

A fuse is installed in each fuse holder of the supplied DC power cable. If a fuse blows, or the transceiver stops functioning, track down the source of the problem if possible, repair it and then replace the damaged fuse with a new rated one (FGB 15 A).

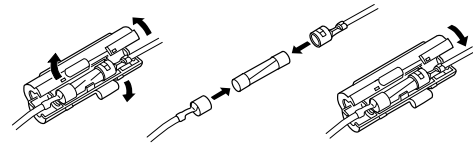

WARNING! NEVER remove the fuse holders from the DC power cable. **USE** only the applicable fuses.

NOTE: Before replacing the fuse, be sure to disconnect the DC cable from the power source.

13 MAINTENANCE

■ Troubleshooting

The following chart is designed to help you correct problems which are not equipment malfunctions.

If you are unable to locate the cause of a problem, or solve it through the use of this chart, contact your nearest Icom Dealer or Service Center.

PROBLEM	POSSIBLE CAUSE	SOLUTION	REF.
Power does not turn ON when [PWR] is pushed.	<ul style="list-style-type: none"> • The power cable is improperly connected. • A fuse is blown. 	<ul style="list-style-type: none"> • Reconnect the DC power cable correctly. • Correct the cause, then replace the fuse with an equivalent fuse. (Fuses are installed in the DC power cable and in the internal PA unit.) 	— —
	<ul style="list-style-type: none"> • Power source voltage is not correct. 	<ul style="list-style-type: none"> • Apply the correct 13.8 V DC. 	—
No sound from the speaker.	<ul style="list-style-type: none"> • The audio volume level is too low. • The squelch is closed. • The Tone squelch is ON in the FM mode. • The external speaker is not connected. • The audio is muted. 	<ul style="list-style-type: none"> • Rotate [VOL][S] clockwise to obtain a suitable listening level. • Rotate [SQL][S] to 12 o'clock position to open the squelch. • Turn OFF the Tone squelch. • Correct the cause, then reconnect. • Push [MUTE] (or any other key) to release mute. 	p. 25 p. 25 p. 56 — p. 27
Sensitivity is too low, and only strong signals can be heard.	<ul style="list-style-type: none"> • The antenna is defective or the coaxial cable connector is shorted or cut. • The Attenuator function is turned ON. • The squelch is set too tight. 	<ul style="list-style-type: none"> • Reconnect to the antenna connector. • Turn OFF the Attenuator function. • Rotate [SQL][S] to adjust the squelch level. 	— p. 14 p. 25
No contact can be made with another station.	<ul style="list-style-type: none"> • Duplex function are ON, and the transmit and receive frequencies are different. 	<ul style="list-style-type: none"> • Turn OFF the Duplex function. • Enter the correct RX and TX frequencies. 	p. 50 p. 24
The displayed frequency is erroneous.	<ul style="list-style-type: none"> • The CPU has malfunctioned. • External factors have caused the fault. 	<ul style="list-style-type: none"> • Reset the transceiver. • Disconnect and connect to the DC power source. 	p. 81 —

PROBLEM	POSSIBLE CAUSE	SOLUTION	REF.
Transmitting is impossible.	<ul style="list-style-type: none"> The PTT Lock function is activated. The Busy Lockout function is activated. The frequency is out of the amateur band. 	<ul style="list-style-type: none"> Set the PTT Lock function to OFF in EXMENU. Set the Busy Lockout function to OFF in EX-MENU. Set the amateur band frequency. 	<p>p. 15 p. 15 p. 24</p>
The displayed frequency does not change when [DIAL][S] is rotated..	<ul style="list-style-type: none"> The Lock function is ON. The Memory or Call channel is selected. 	<ul style="list-style-type: none"> Turn OFF the function. Push [V/MHz SCAN][S] to select the VFO mode. 	<p>p. 25 p. 23</p>
A Programmed scan does not start.	<ul style="list-style-type: none"> The VFO mode is not selected. The same frequencies are entered into the scan edges. 	<ul style="list-style-type: none"> Push [V/MHz SCAN][S] to select the VFO mode. Enter different frequencies into the scan edges. 	<p>p. 23 p. 38</p>
A Memory scan does not start.	<ul style="list-style-type: none"> The Memory mode is not selected. 2 or more memory channels have not been programmed. 	<ul style="list-style-type: none"> Push [MR CALL][S] to select the Memory mode. Program more than 2 Memory channels. 	<p>p. 23 p. 30</p>
Cannot receive on the SUB band.	<ul style="list-style-type: none"> The SUB band mute function is activated. 	<ul style="list-style-type: none"> Turn OFF the function. 	<p>p. 16</p>
While transmitting, automatically switches to reception.	<ul style="list-style-type: none"> The Time-Out Timer function is activated. 	<ul style="list-style-type: none"> Turn OFF the function. 	<p>p. 15</p>

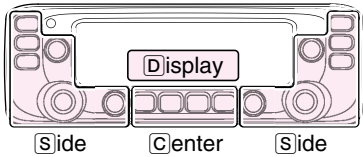

The [C], [S], or [D] in the instructions indicate the area of the controller.
 [C]: Center
 [S]: Side
 [D]: Display

14 INFORMATION

COUNTRY CODE LIST

• ISO 3166-1

	Country	Codes		Country	Codes
1	Austria	AT	18	Liechtenstein	LI
2	Belgium	BE	19	Lithuania	LT
3	Bulgaria	BG	20	Luxembourg	LU
4	Croatia	HR	21	Malta	MT
5	Czech Republic	CZ	22	Netherlands	NL
6	Cyprus	CY	23	Norway	NO
7	Denmark	DK	24	Poland	PL
8	Estonia	EE	25	Portugal	PT
9	Finland	FI	26	Romania	RO
10	France	FR	27	Slovakia	SK
11	Germany	DE	28	Slovenia	SI
12	Greece	GR	29	Spain	ES
13	Hungary	HU	30	Sweden	SE
14	Iceland	IS	31	Switzerland	CH
15	Ireland	IE	32	Turkey	TR
16	Italy	IT	33	United Kingdom	GB
17	Latvia	LV			

DISPOSAL



The crossed-out wheeled-bin symbol on your product, literature, or packaging reminds you that in the European Union, all electrical and electronic products, batteries, and accumulators (rechargeable batteries) must be taken to designated collection locations at the end of their working life. Do not dispose of these products as unsorted municipal waste. Dispose of them according to the laws in your area.

FCC INFORMATION

• FOR CLASS B UNINTENTIONAL RADIATORS:

This equipment has been tested and found to comply with the limits for a Class B digital device, pursuant to part 15 of the FCC Rules. These limits are designed to provide reasonable protection against harmful interference in a residential installation. This equipment generates, uses and can radiate radio frequency energy and, if not installed and used in accordance with the instructions, may cause harmful interference to radio communications. However, there is no guarantee that interference will not occur in a particular installation. If this equipment does cause harmful interference to radio or television reception, which can be determined by turning the equipment off and on, the user is encouraged to try to correct the interference by one or more of the following measures:

- Reorient or relocate the receiving antenna.
- Increase the separation between the equipment and receiver.
- Connect the equipment into an outlet on a circuit different from that to which the receiver is connected.
- Consult the dealer or an experienced radio/TV technician for help.

CAUTION: Changes or modifications to this device, not expressly approved by Icom Inc., could void your authority to operate this device under FCC regulations.

[DIAL] operation during a scan	37
1750 Hz tone burst	49

A

AF Output	75
All Reset	81
Antenna	
Coaxial cable	67
Installing	67
Location	67
Audio mute function	27
Auto repeater function	52
Audio volume setting	25

B

Bank	
Bank link scan	36
Bank scan	36
Directly entering into a Memory bank	33
Entering a Bank name	34
Full bank scan	36
Memory bank scan	36, 43
Selecting the Memory bank mode	33
Setting a Memory bank	32
Band Scan	36
Band memory scan	36
Basic operation	23
Bluetooth® operation	71
Custom key	76
Custom Key Beep	76

Deleting a headset from the pairing list	77
Disconnecting from a headset	77
Headset settings	
AF Output	75
VS-3 headset	76
VOX function	74
Pairing with a headset	73
Resetting the installed Bluetooth® unit	78
The maximum number of paired headsets	77

C

Call channel mode	23
Selecting a Call channel	29
Class B unintentional radiators	85
Clearing	
Clearing a Memory channel	35
Clearing the skip frequencies	42
Cloning	61
Cloning between transceivers	61
Cloning from a PC using a cloning cable	61
Coaxial cable	67
Connection	
Connecting a microphone	63
Connecting the controller to the main unit	63
When using the MBA-4 combination bracket	63
Connecting to a battery	68
Connecting to a DC power supply	64

 Continued on the next page.

INDEX

C (Continued)

Controller	
Display	2
Front panel	1
Connecting the controller to the main unit	63
Copy	
Copying Memory content to another Memory channel ..	31
Copying Memory content to the VFO	31
Country code list	85

D

Duplex operation	50, 51
Setting the duplex direction	50
Setting the frequency offset	50
Frequency range and offset direction	52

DTMF

Entering a DTMF code	54
Selecting the DTMF transmit speed	56
Setting the DTCS code	59
Setting the DTCS polarity	59
Transmitting DTMF code	55
Transmitting DTMF code (Direct Input)	55
Transmitting DTMF code (DTMF Memory)	55
Using the DTMF Memory	54

E

Electromagnetic Interference	71
EXMENU	12
Bluetooth® items	16
Display items	15

DUP/TONE items	13
Function items	14
Home channel items	16
Mode and Tuning step items	12
Other items	17
Scan items	13
Sound items	16
Explicit definitions	i

F

FCC information	85
Frequency setting	24
Full scan	36
Full memory scan	36
Fuse replacement	82

H

Home channel	
Home Channel Beep function	53
Home channel operation	53
Setting the Home channel	53

I

Important	i
Installation and connections	63
Installing in a vehicle	66
Using the mounting bracket	66
Installing the controller	64
Into your vehicle	64
To a flat surface	65

Installing the main unit 66
 Installing the UT-133/UT-133A 72
 Installing the remote controller 66
 Internal duplexer 67

L

Lock function 25

M

Maintenance 81
 MAIN band selection 23
 Main unit 5
 Main unit installation 66
 Memory operation 28
 Clearing a Memory channel 35
 Copying Memory content to another Memory channel .. 31
 Copying Memory content to the VFO 31
 Entering a Memory name 34
 Full memory scan 36
 General description 28
 Memory channel assignment to a Memory bank 32
 Memory channel content 28
 Memory mode 23
 Memory scan 36, 43
 Mode memory scan 36
 Selecting a Memory channel 29
 Selecting the Memory bank mode 33
 Memory write into a Memory or Call channel 30
 Writing into a blank channel 30
 Writing into the selected channel 30

MENU mode 9
 EXMENU 12
 MENU items 18
 MENU mode construction 9
 MENU mode screen 9
 Selecting the MENU item 11
 Setting items 12

Microphone

Connecting a microphone 63
 HM-207 microphone 6
 Key functions for [F-1] or [F-2]
 During RX/Standby 8
 During TX 8
 Microphone connector information 5
 Setting the microphone gain level 27

Mode memory scan 36

Mode selection

Call channel mode 23
 Memory mode 23
 VFO mode 23
 Weather channel mode 23

Monitor function 27

O

Off band indication 51
 One-Touch PTT 76
 Operating band selection 24
 Operating mode selection 26
 Options 70

INDEX

P	
Panel description	1
Partial Reset	81
Power protect function	82
Power Save	76
Precautions	ii
Priority watch	45
VFO and a Memory/Bank scan	45, 47
VFO and a Priority channel	45, 46
VFO frequency and a Memory/Bank scan	47
VFO frequency and a Priority channel	46
Program link scan	36
Program scan	36
PTT Beep	76

R	
Remote controller installation	66
Repeater and duplex operation	48
Repeater operation	48
Checking the repeater input signal	49
Resetting	81
All Reset	81
Partial Reset	81
Resetting the installed Bluetooth® unit	78

S	
Scan function	36
Bank link scan	36
Bank scan	36
Entering scan edges	38
VFO scan	36
Full bank scan	36
Full scan	36
Program link scan	36
Program scan	36
Selected band scan	36
Tuning step for a VFO scan	37
Memory scan	36, 43
Full memory scan	36
Memory (skip) scan	43
Memory bank scan	36, 43
Mode memory scan	36
Selected band memory scan	36
Receive mode during a scan	38
Scan name	38
Scan Stop Beep function	37
Skip function	37
Clearing the skip frequencies	42
Setting and clearing skip channels	44
Setting and clearing the skip frequencies	42
Setting the skip frequencies	42
Setting the temporary skip function	44

Specifications	79
General	79
Receiver	80
Transmitter	80
Spurious signals	82
Squelch level setting	25
Supplied accessories	i

T

Table of contents	iv
The number of the Memory channel	28
Tone Squelch function	56
Setting the Repeater Tone frequency	58
Setting the Tone frequency	58
Transmitting	26
Troubleshooting	83
Tuning	
Tuning step for a VFO scan	37
Selecting a tuning step	25
Selecting the 1 MHz tuning	24

U

UT-133/UT-133A	70, 72
Installing	72

V

VFO mode	23
VFO mode scan	41
VFO scan	36
VFO scan and a Memory/Bank scan	47
VFO scan and a Priority channel	46
VOX function	74
Setting the VOX level	74
Using the VOX function	74
VOX Delay	75
VOX-related settings	75
VOX Time-Out Timer	75
VS-3 headset	76
Power Save	76
PTT Beep	76

W

Weather alert function	60
Weather channel mode	23
Weather channel operation (USA version only)	60
Weather channel selection	60
When a signal is received	38

Count on us!

#02 EUR

<Intended Country of Use>											
<input checked="" type="checkbox"/>	AT	<input checked="" type="checkbox"/>	BE	<input checked="" type="checkbox"/>	CY	<input checked="" type="checkbox"/>	CZ	<input checked="" type="checkbox"/>	DK	<input checked="" type="checkbox"/>	EE
<input checked="" type="checkbox"/>	FI	<input checked="" type="checkbox"/>	FR	<input checked="" type="checkbox"/>	DE	<input checked="" type="checkbox"/>	GR	<input checked="" type="checkbox"/>	HU	<input checked="" type="checkbox"/>	IE
<input checked="" type="checkbox"/>	IT	<input checked="" type="checkbox"/>	LV	<input checked="" type="checkbox"/>	LT	<input checked="" type="checkbox"/>	LU	<input checked="" type="checkbox"/>	MT	<input checked="" type="checkbox"/>	NL
<input checked="" type="checkbox"/>	PL	<input checked="" type="checkbox"/>	PT	<input checked="" type="checkbox"/>	SK	<input checked="" type="checkbox"/>	SI	<input checked="" type="checkbox"/>	ES	<input checked="" type="checkbox"/>	SE
<input checked="" type="checkbox"/>	GB	<input checked="" type="checkbox"/>	IS	<input checked="" type="checkbox"/>	LI	<input checked="" type="checkbox"/>	NO	<input checked="" type="checkbox"/>	CH	<input checked="" type="checkbox"/>	BG
<input checked="" type="checkbox"/>	RO	<input checked="" type="checkbox"/>	TR	<input checked="" type="checkbox"/>	HR						

#03 ITR

<Intended Country of Use>											
<input type="checkbox"/>	AT	<input type="checkbox"/>	BE	<input type="checkbox"/>	CY	<input type="checkbox"/>	CZ	<input type="checkbox"/>	DK	<input type="checkbox"/>	EE
<input type="checkbox"/>	FI	<input type="checkbox"/>	FR	<input type="checkbox"/>	DE	<input type="checkbox"/>	GR	<input type="checkbox"/>	HU	<input type="checkbox"/>	IE
<input checked="" type="checkbox"/>	IT	<input type="checkbox"/>	LV	<input type="checkbox"/>	LT	<input type="checkbox"/>	LU	<input type="checkbox"/>	MT	<input type="checkbox"/>	NL
<input type="checkbox"/>	PL	<input type="checkbox"/>	PT	<input type="checkbox"/>	SK	<input type="checkbox"/>	SI	<input type="checkbox"/>	ES	<input type="checkbox"/>	SE
<input type="checkbox"/>	GB	<input type="checkbox"/>	IS	<input type="checkbox"/>	LI	<input type="checkbox"/>	NO	<input type="checkbox"/>	CH	<input type="checkbox"/>	BG
<input type="checkbox"/>	RO	<input type="checkbox"/>	TR	<input type="checkbox"/>	HR						

A-7194H-1EX-②

Printed in Japan

© 2014–2016 Icom Inc.

Printed on recycled paper with soy ink.

Icom Inc.

1-1-32 Kamiminami, Hirano-ku, Osaka 547-0003, Japan