



FULL MANUAL

VHF AIR BAND TRANSCEIVERS

IC-A16
IC-A16E

INTRODUCTION

1 ACCESSORIES ATTACHMENTS

2 PANEL DESCRIPTION

3 BATTERY CHARGING

4 BASIC OPERATION

5 SCAN OPERATION

6 MEMORY OPERATION

7 OTHER FUNCTIONS

8 HEADSET CONNECTION

9 SET MODE

10 SPECIFICATIONS AND OPTIONS

11 TROUBLESHOOTING

INDEX

INTRODUCTION

Thank you for choosing this Icom product.

This product is designed and built with Icom's state of the art technology and craftsmanship.

With proper care, this product should provide you with years of trouble-free operation.

Important

READ ALL INSTRUCTIONS carefully before using the transceiver.

This **FULL MANUAL** contains advanced features and operating instructions for the IC-A16 and IC-A16E.

READ also the **BASIC MANUAL** that supplied with the transceiver.

KEEP MANUALS, because it contains important operating information that may be useful in the future.

Table of contents

INTRODUCTION	i	8 HEADSET CONNECTION	12
■ Important	i	■ Using a Bluetooth® headset	12
1 ACCESSORIES ATTACHMENTS	1	■ Using a wired headset.....	13
■ Supplied accessories	1	9 SET MODE	14
■ Attaching accessories	1	■ Using the Set mode.....	14
2 PANEL DESCRIPTION	4	■ Set mode items	14
■ Front, top, and side panels.....	4	10 SPECIFICATIONS AND OPTIONS	16
■ Keypad	4	■ Specifications	16
■ Function display	5	■ Options.....	17
3 BATTERY CHARGING	6	11 TROUBLESHOOTING	18
■ Battery charger.....	6	■ Troubleshooting.....	18
4 BASIC OPERATION	7	INDEX	19
■ Receiving and transmitting.....	7		
■ Selecting the 121.5 MHz emergency frequency .	7		
5 SCAN OPERATION	8		
■ Using the Scan function	8		
■ Scan types.....	8		
■ TAG setting.....	8		
6 MEMORY OPERATION	9		
■ Description	9		
■ Editing Memory channels.....	9		
7 OTHER FUNCTIONS	11		
■ Using the Home function	11		
■ Using a Weather channel	11		
■ Using the Duplex function	11		
■ Using the Side tone function	11		

Icom, Icom Inc. and the Icom logo are registered trademarks of Icom Incorporated (Japan) in Japan, the United States, the United Kingdom, Germany, France, Spain, Russia, Australia, New Zealand and/or other countries.

The Bluetooth® word mark and logos are registered trademarks owned by Bluetooth SIG, Inc. and any use of such marks by Icom Inc. is under license.

Other trademarks and trade names are those of their respective owners.

3M, PELTOR, and WS are trademarks of 3M Company.

All other products or brands are registered trademarks or trademarks of their respective holders.

1 ACCESSORIES ATTACHMENTS

Supplied accessories

Battery pack

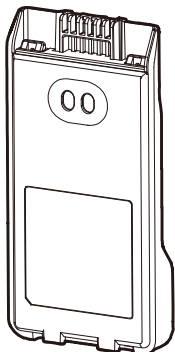

Belt clip



Handstrap

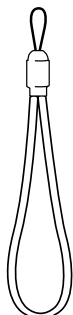

Antenna

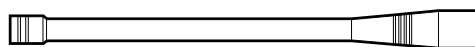

Battery charger*

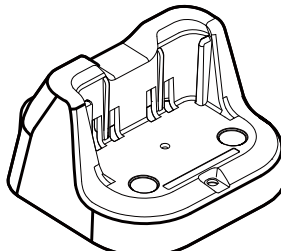

Power adapter*

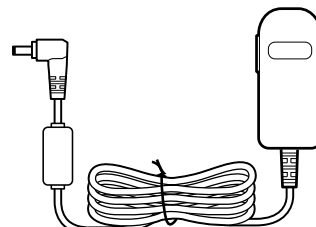

* May not be supplied, or the shape may be different, depending on the transceiver version.

Attaching accessories

◇ Antenna

Connect the supplied antenna to the antenna connector.

CAUTION:

- **DO NOT** carry the transceiver by holding only the antenna.
- **DO NOT** connect an antenna other than the supplied antenna, or those listed in this manual.
- **DO NOT** transmit without an antenna.

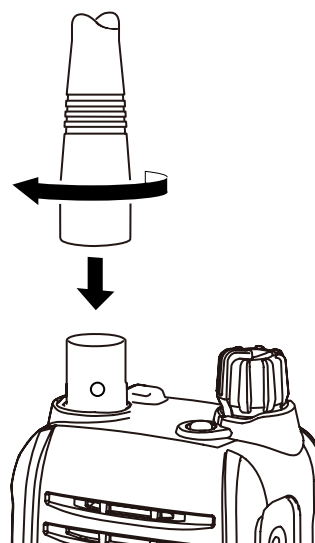

Attaching accessories (Continued)

◇ Battery pack/Battery case

CAUTION: DO NOT attach or detach the battery pack or the battery case when the transceiver is wet or soiled. This may result in water or dust getting into the transceiver, battery pack, or battery case and may damage them.

To attach:

1. Slide the battery pack in the direction of the arrow. **(1)**
2. Push the battery pack until the battery sliding locks make a 'click' sound. **(2)**

To detach:

1. Pull both battery sliding locks in the direction of the arrow. **(1)**
 - The battery pack is then released.
2. Lift up to detach the battery pack. **(2)**

NOTE: Keep the battery pack terminals clean. It's a good idea to occasionally clean them.

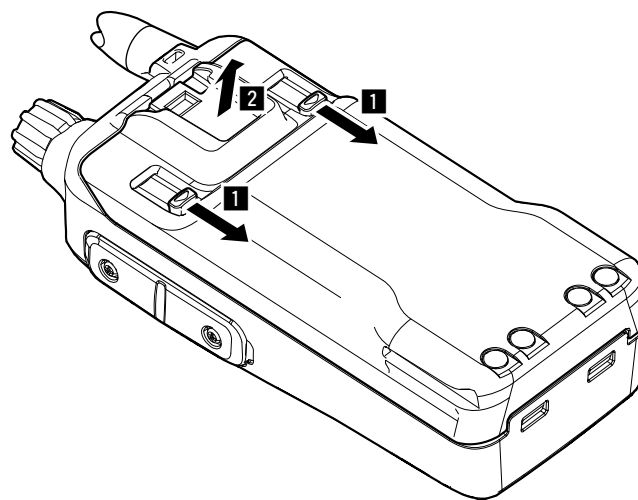
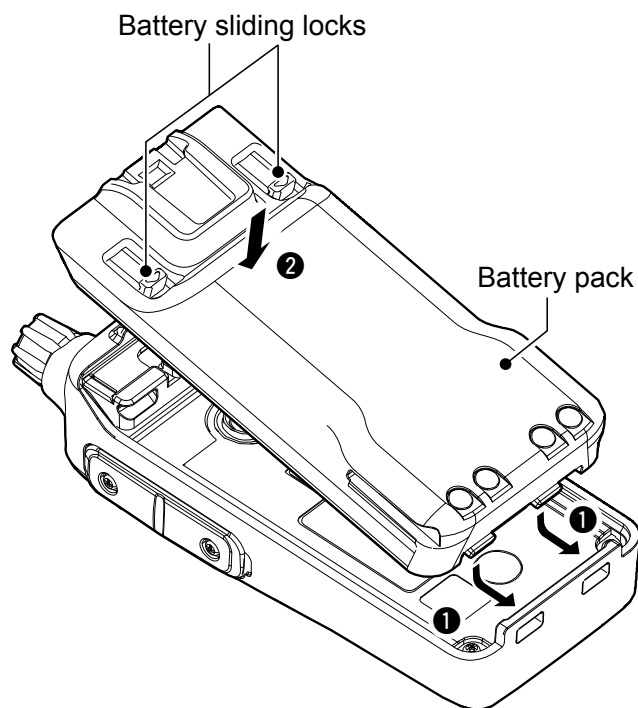

1 ACCESSORIES ATTACHMENTS

Attaching accessories (Continued)

◇ Belt clip

To attach:

1. Remove the battery pack from the transceiver, if it is attached.
2. Slide the belt clip in the direction of the arrow until the belt clip is locked and makes a 'click' sound.

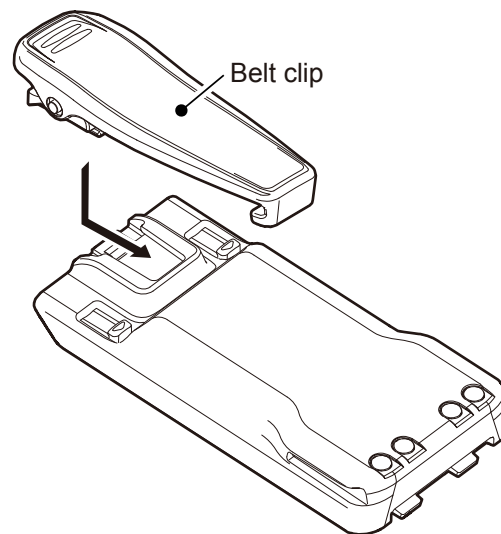

To detach:

Lift the tab up (❶), and slide the belt clip in the direction of the arrow (❷).

BE CAREFUL! Don't break your fingernail.

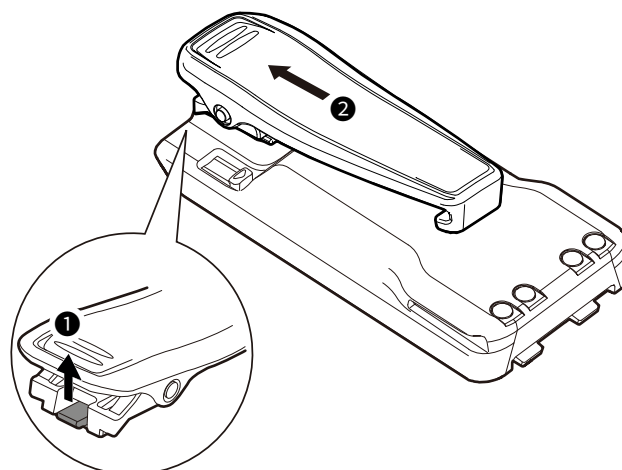

2 PANEL DESCRIPTION

Front, top, and side panels

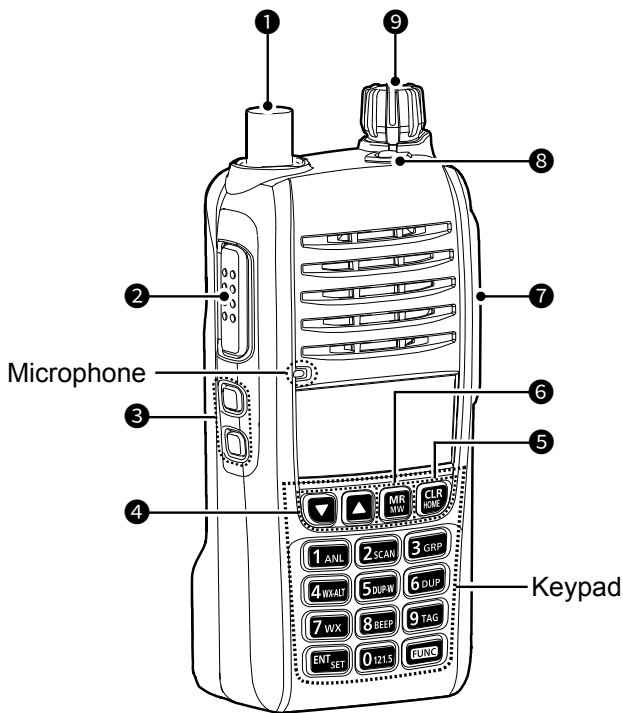

1 ANTENNA CONNECTOR

Connect the supplied antenna. (p. 1)

2 PTT SWITCH [PTT]

Hold down to transmit, release to receive. (p. 7)

3 SQUELCH ADJUSTMENT KEYS [SQL▲]/[SQL▼]

Push to adjust the squelch level.

4 UP/DOWN KEYS [▲]/[▼]

- Push to change or select the frequency, Memory channel, Set mode settings, and so on.
- While scanning, push to change the scanning direction.

5 CLEAR/HOME KEY [CLR]/[HOME]

- Push to return to the VFO mode.
- Hold down for 2 seconds to reset the Set mode settings to default.

6 MEMORY/MEMORY WRITE KEY [MR]/[MW]

- Push to enter the Memory Channel Selection mode. (p. 7)
- Push [FUNC], and then push this key to enter the Memory Write mode. (p. 9)

7 HEADSET JACK

Connects a third party headset through the optional headset adapter. (p. 13)

8 LOCK KEY [LCK]

- Push to lock the keypad.
- Hold down for 2 seconds to unlock the keypad.

9 VOLUME/POWER SWITCH [VOL]

- Rotate to turn the transceiver ON or OFF.
- Rotate to adjust the audio output level.

Keypad

- Push to set the frequency, select a Memory channel, and so on.
- Push [FUNC], and then push or hold down another key within 3 seconds to use the secondary functions listed below.

KEYS	FUNCTIONS
Push [1]/[ANL]	Turn the Automatic Noise Limiter (ANL) function ON or OFF.
Push [2]/[SCAN]	Start a scan. ① Push [CLR] to stop a scan.
Push [3]/[GRP]	In the Memory mode, enter the Memory Selection mode.
Push [4]/[WX-ALT]*	Turn the Weather Alert function ON or OFF.
Push [5]/[DUP-W]*	Enter the Duplex Frequency Entry mode. ① Confirm the NAV band frequency is selected.
Push [6]/[DUP]*	Turn the Duplex function ON or OFF. ① Confirm the NAV band frequency is selected.
Push [7]/[WX]*	Enter the Weather Channel Selection mode.
Push [8]/[BEEP]	Turn the Key beep ON or OFF.
Push [9]/[TAG]	Tag or untag the selected Memory channel or Weather Channel*.
Hold down [ENT]/[SET] for 1 second	Enter the Set mode.
Push [0]/[121.5]	Select the emergency frequency.

*For only the USA version.

Function display

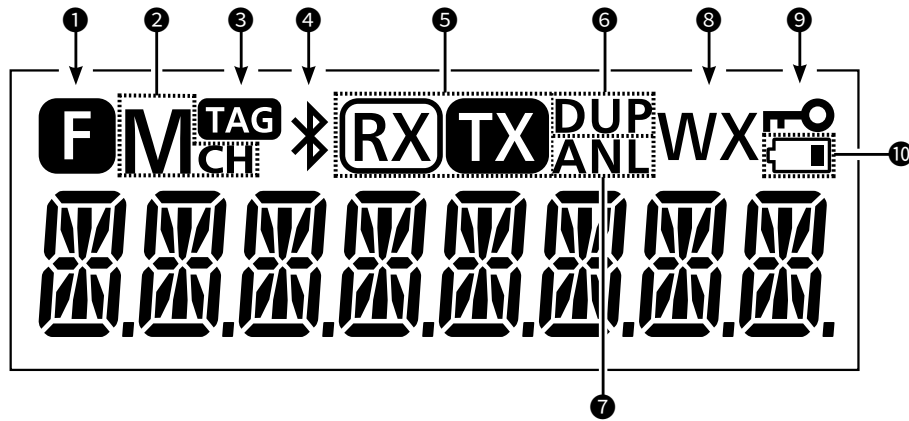

1 FUNCTION ICON

Displayed for 3 seconds when you push [FUNC], to use secondary functions assigned to a key.

2 MEMORY CHANNEL ICON

Displayed when a Memory channel is selected. (p. 7)

3 TAG ICON

Displayed when a tagged Memory channel is selected. (p. 8)

4 BLUETOOTH ICON (For only the transceiver with the built-in Bluetooth unit)

Displayed when a Bluetooth headset is connected. (p. 12)

5 RX/TX ICON

Displayed while receiving or transmitting. (p. 7)

6 DUPLEX ICON

- Displayed when the Duplex function is ON. (p. 11)
- Blinks while entering a duplex frequency into a Memory channel. (p. 11)

7 AUTOMATIC NOISE LIMITER ICON

Displayed when the Automatic Noise Limiter function is ON. (p. 7)

8 WEATHER ALERT ICON (For only the USA version.)

Displayed when the Weather Alert function is ON. (p. 11)

9 LOCK ICON [L-O]

Displayed when the Lock function is ON. (p. 4)

10 LOW BATTERY ICON

- Displayed when charging is required.
- Blinks when the battery exhausted.

3 BATTERY CHARGING

Battery charger

NOTE: Before attaching or detaching a battery pack, BE SURE to turn OFF the transceiver by rotating [VOL] fully counter clockwise until it makes a “click” sound. Otherwise, a transceiver malfunction could occur.

◇ Supplied battery charger

Charging time:

Approximately 3.5 hours for the BP-280

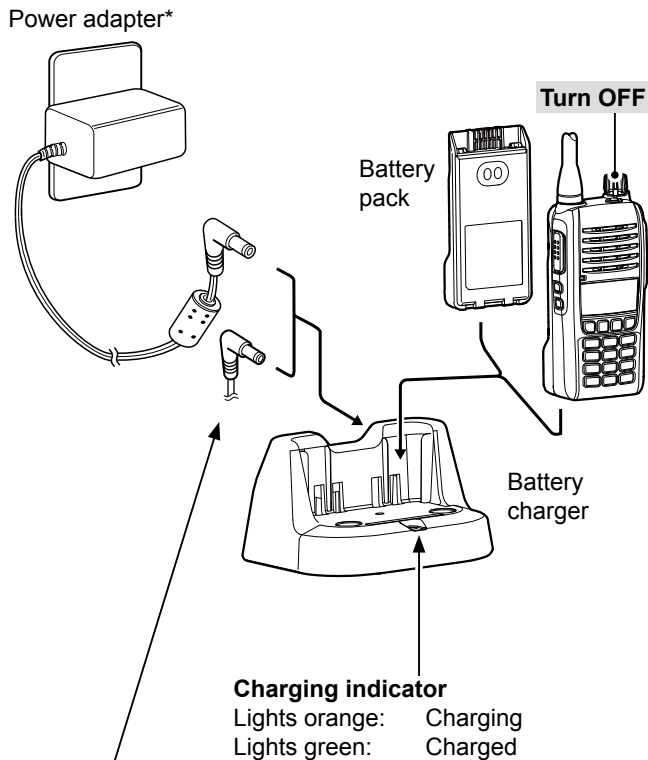

The CP-23L (for a 12 V cigarette lighter socket) can be used instead of the power adapter.

* May not be supplied, or the shape may be different, depending on the transceiver version.

NOTE: If the charging indicator alternately blinks green and orange, remove the battery pack or the transceiver from the charger, then reinsert it.

◇ Optional BC-214 MULTI CHARGER

Charging time:

Approximately 2 to 3 hours for the BP-280

Additionally needed item (purchase separately):

The BC-157S AC ADAPTER or the OPC-656 DC POWER CABLE

CAUTION: DO NOT reverse the polarity when connecting the OPC-656 to a power source. This will ruin the battery charger.
Red: ⊕, Black: ⊖

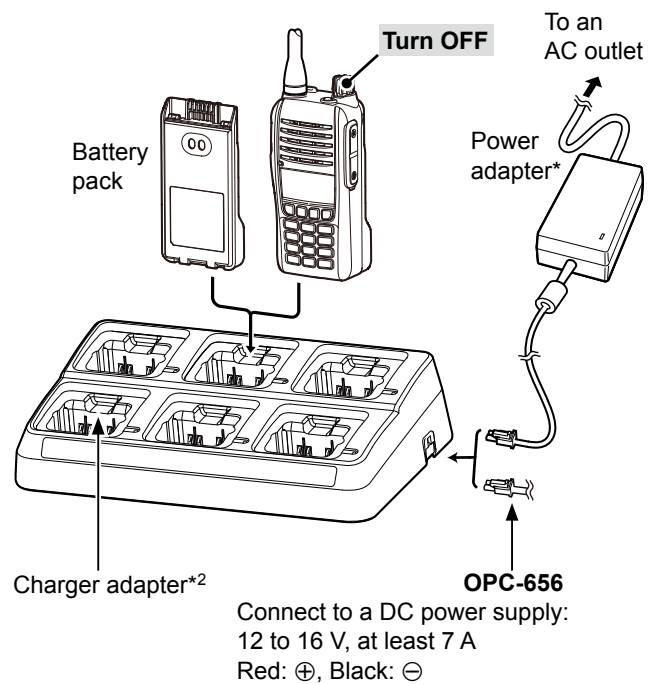

*1 A different type, or no power adapter is supplied, depending on the charger version.

*2 Charger adapter's shape may differ, depending on the charger version.

4 BASIC OPERATION

Receiving and transmitting

◇ Setting the frequency

- ① If the transceiver is in the Memory mode, push [CLR]/[HOME] to exit the Memory mode.
- Use the keypad to set the frequency.

○ Selecting a Memory channel

1. Push [MR]/[MW] to enter the Memory mode.
 - “M_{ch}” is displayed.
 - The memory channel’s frequency or name is displayed, if it is entered.
2. Push [▲] or [▼] to select a channel.

TIP: To change the selected group:

- ① Confirm the transceiver is in the Memory mode.
 1. Push [FUNC], and then push [GRP].
 2. Push [▲] or [▼] to select a group, and then push [ENT]/[SET].

◇ Receiving

When receiving a signal, “RX” is displayed and audio should be heard.

- ① Rotate [VOL] to adjust the audio output level.



◇ Adjusting the squelch level

- Push [SQL▲]/[SQL▼] to adjust the squelch level until the noise just disappears when no signal is received.
 - The squelch level is displayed while adjusting.

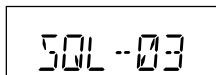

◇ Using the Automatic Noise Limiter (ANL) function

The function reduces noise components in the received signal, such as those caused by engine ignition systems.

- Push [FUNC], and then push [ANL] to turn the function ON or OFF.
 - “ANL” is displayed while the function is ON.

◇ Transmitting

CAUTION: DO NOT transmit without an antenna.

- Hold down [PTT], and then speak at your normal voice level.
 - “TX” is displayed.

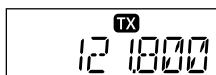

NOTE: When the battery is exhausted, beep sounds and the transceiver stops transmitting, even if you hold down [PTT].

Selecting the 121.5 MHz emergency frequency

In case of an emergency, you can immediately select the 121.5 MHz emergency frequency.

- Push [FUNC], and then push [121.5] to select the emergency frequency.
 - ① Push [CLR] to return to the previously selected frequency.

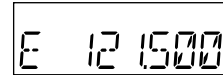

5 SCAN OPERATION

Using the Scan function

- Push [FUNC], and then push [2]/[SCAN] to start a scan.
 - ① Push [▲] or [▼] to change the scanning direction.
 - ① When receiving a signal, the scan pauses and "RX" is displayed until the signal disappears.
 - ① Push [CLR]/[HOME] to stop a scan.

Scan types

The transceiver has 2 scan functions, as shown below.

◇ VFO scan

Repeatedly scans all frequencies over the COM band.

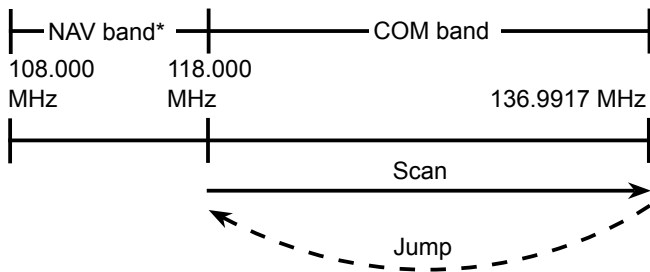

*The USA version transceiver scans NAV band frequencies as well, depending on the presetting.

◇ Memory channel scan

Repeatedly scans tagged memory channels belonging to the same group.*

*Skips all untagged memory channels.

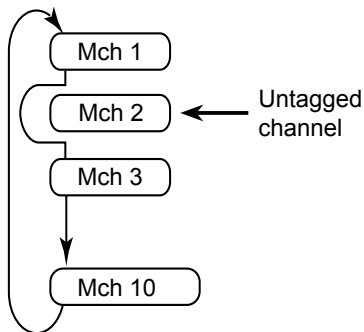

◇ Weather channel scan

(For only the USA version)

Repeatedly scans Weather channels. See page 11 for details.

TAG setting

Select whether or not to tag selected channels for scanning. Untagged channels are skipped during a scan.

1. Push [MR]/[MW] to enter the Memory mode.
2. Select a channel to tag or untag.

TIP: To change the selected group:

1. Push [FUNC], and then push [3]/[GRP].
2. Push [▼] or [▲] to select a group, and then push [ENT]/[SET].

3. Push [FUNC], and then push [9]/[TAG] to tag or untag the selected channel.

① "TAG" is displayed if the channel is tagged.

6 MEMORY OPERATION

Description

The transceiver has 200 memory channels to save often-used frequencies. The frequency and channel name can be saved into each memory channel.

NOTE:

- Editing Memory channels may be disabled, depending on the transceiver's presetting. Ask your dealer for details.
- Preset Memory channel contents may differ, or nothing may be preset.

Editing Memory channels

◇ Entering frequencies into the Memory channels

You can enter often-used frequencies by following the steps below.

1. Setting the frequency to enter

- Use the keypad, or push [▲] or [▼] to set the frequency.
- ① Confirm the VFO mode is selected.

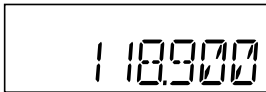

2. Selecting a channel to enter the frequency

1. Push [FUNC], and then push [MR]/[MW] to enter the Memory Write mode.
 - "MCH" blinks.
2. Push [▲] or [▼] to select a channel to enter the frequency.

① The group and channel number is displayed for 1 second, when the channel without a name or frequency is entered.

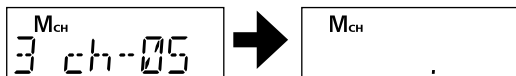

3. Push [ENT] to enter the frequency into the Memory channel.

TIP: To change the selected group:

1. Push [FUNC], and then push [3]/[GRP].
2. Push [▼] or [▲] to select a group, and then push [ENT]/[SET].

- The transceiver automatically returns to the VFO mode.

◇ Entering/Editing the Memory channel name

The memory channel can display an 8 character name instead of the channel frequency.

To enter a memory name, or edit an existing memory name, follow the steps below.

1. Selecting the channel to enter/edit the name

1. Push [FUNC], and then push [MR]/[MW] to enter the Memory Write mode.
 - A memory channel name may be displayed.
2. Push [▲] or [▼] to select a channel to edit.

2. Entering/editing the name

1. Push [MR]/[MW].
 - "MCH" blinks.
2. Enter a memory name.

① You can enter the characters A to Z, 0 to 9, -, and a space.

Usable characters and key assignment:

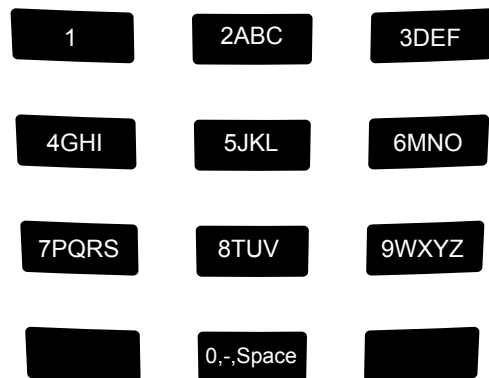

① Information

- Push [↔] to enter a dot.
 - Push [▼] or [▲] to move the cursor.
 - The cursor automatically moves forward when a different key is pushed.
 - Push [CLR] to cancel entering or editing.
 - To erase a character, overwrite with a space (displayed as "_").
3. Push [ENT] to save the entered name and exit the Memory Write mode.

Editing memory channels (Continued)

◇ Copying a frequency from a Memory channel

You can copy the selected channel's frequency to the VFO mode. The function is useful to search signals around the selected channel's frequency.

1. Push [MR]/[MW] to enter the Memory mode.
2. Push [▲] or [▼] to select a channel to copy.
3. Push [FUNC], and then push [MR]/[MW] to copy the channel's frequency.
 - The frequency is copied into the VFO mode.

◇ Deleting a Memory channel

You can delete an unwanted memory channel.

1. Push [MR]/[MW] to enter the Memory mode.
2. Push [▲] or [▼] to select a channel to delete.
3. Push [FUNC], and then push [CLR].
 - "DELETE?" is displayed.
4. Push [ENT] to delete the channel.

7 OTHER FUNCTIONS

Using the Home function

The Home function resets the Set mode settings to default.

- Hold down [CLR]/[HOME] for 2 seconds to reset the transceiver to its default settings.

Using a Weather channel

(For only the USA version)

The transceiver has 10 preset Weather channels. You can use these channels to monitor broadcasts from the National Oceanographic and Atmospheric Administration (NOAA). The transceiver automatically detects a Weather alert tone on the selected Weather channel, or while scanning.

◇ Selecting a Weather channel

- Push [FUNC], and then push [7]/[WX] to enter the Weather Channel Selection mode.
 - ① Push [▲] or [▼] to select a weather channel.
 - ① Push [CLR]/[HOME] to exit the Weather Channel Selection mode.

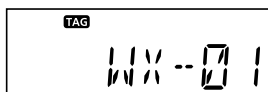

◇ Receiving a Weather Alert

NOAA broadcast stations transmit a weather alert tone before any important weather announcements. The transceiver can detect the Weather Alert and sounds a beep tone.

- Push [FUNC], and then push [4]/[WX-ALT] to turn the Weather Alert function ON or OFF.
 - ① "WX" is displayed when the function is ON.

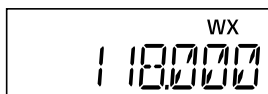

◇ Scanning Weather channel

Repeatedly scans Weather channels.

1. Push [FUNC], and then push [7]/[WX] to enter the Weather Channel Selection mode.
2. Push [FUNC], and then push [2]/[SCAN] to start a scan.
 - ① Push [▲] or [▼] to change the scanning direction.
 - ① When receiving a signal, the scan pauses and "RX" is displayed until the signal disappears.
 - ① Push [CLR]/[HOME] to stop a scan.

Using the Duplex function

(For only the USA version)

The duplex function enables you to call a flight service station while receiving on a VOR frequency. Turn ON the function, and set the flight service station's frequency on the Menu screen.

◇ Setting the Duplex frequency

- ① Confirm the VFO mode is selected.
 1. Set the NAV band frequency (108.000 ~ 117.975 MHz).
 2. Push [FUNC], and then push [5]/[DUP-W].
 - "DUP" blinks and the transmit frequency is displayed.
 3. Set the flight service station frequency, and then push [ENT]/[SET].
 - The NAV band frequency is displayed.

◇ Using the Duplex function

- ① Confirm the VFO mode is selected.
 1. Set the NAV band frequency (108.000 ~ 117.975 MHz).
 2. Push [FUNC], and then push [6]/[DUP] to enable the function.
 - "DUP" is displayed.
 3. Hold down [PTT] to transmit on the entered flight service station frequency.
 - ① Push [FUNC], and then push [6]/[DUP] to disable the function.

Using the Side tone function

The Side tone function outputs the transmitting audio to the headset connected to the transceiver.

- While transmitting, push [▲] or [▼] to adjust the side tone output level.
 - The side tone level is displayed while adjusting.

NOTE:

When using the optional HM-240 speaker microphone, set the side tone output level to "0." Otherwise, your voice will be heard from the speaker while transmitting.

8 HEADSET CONNECTION

Using a Bluetooth® headset

(For only transceivers with the built-in Bluetooth unit)

Transceivers with the built-in Bluetooth unit can operate with Bluetooth headsets. The communication range of Bluetooth is approximately 10 meters (33 ft).

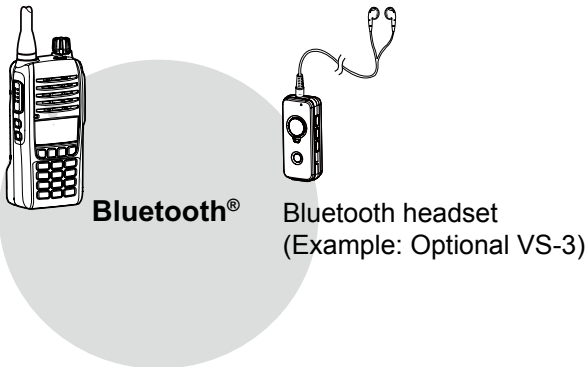

NOTE: The Bluetooth communication range may vary, depending on the environment where you operate the device.

◇ Electromagnetic Interference

When you use a Bluetooth device, pay attention to the following:

Bluetooth devices operate in the 2.4 GHz band. The 2.4 GHz band is also used by other devices, such as Wireless LAN products, microwave ovens, RFID systems, amateur radio stations, and so on.

When using this device near such devices, interference may occur, causing a decrease in communication speed, and an unstable connection. In such cases, use this device away from the other devices, or stop using those devices.

◇ Pairing with a device

You can pair maximum of 4 Bluetooth headsets to the transceiver.

① These instructions describe pairing with the VS-3 Bluetooth® headset, as an example.

1. Turning ON the transceiver's Bluetooth function

1. Push [FUNC], and then hold down [ENT]/[SET] for 1 second to enter the Set mode.
2. Select "BT SET," and then push [ENT]/[SET].
3. Select "ON," and then push [ENT]/[SET].

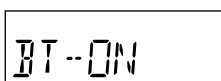

4. Push [CLR]/[HOME] to exit the Set mode.

2. Entering the VS-3 Pairing mode

Refer to the VS-3's instruction manual for details.

3. Pairing and connecting the Bluetooth headset

1. Push [FUNC], and then hold down [ENT]/[SET] for 1 second to enter the Set mode.
2. Select "PAIRING," and then push [ENT]/[SET].

BT SET > PAIRING

- The transceiver searches for a headset.
 - ① Push [CLR] to cancel searching.
 - "SUCCESS" and "📶" is displayed if the headset or device is correctly connected.
3. Push [CLR]/[HOME] twice to exit the Set mode.

◇ Disconnecting a paired device

You can disconnect a paired Bluetooth device if it is not being used.

1. Push [FUNC], and then hold down [ENT]/[SET] for 1 second to enter the Set mode.
2. Select "DISCON," and then push [ENT]/[SET].

BT SET > DISCON

- "SUCCESS" is displayed and the headset is disconnected.
3. Push [CLR]/[HOME] twice to exit the Set mode.

◇ Unpairing a device

Disconnct a connected headset or device before unpairing.

1. Push [FUNC], and then hold down [ENT]/[SET] for 1 second to enter the Set mode.
2. Select "CONNECT," and then push [ENT]/[SET].

BT SET > CONNECT

- A paired device's name is displayed.
 - ① Push [MR]/[MW] to display the Bluetooth device address.
 - ① Push [▲] or [▼] to select other paired headsets, if necessary.
3. Push [FUNC], and then push [CLR]/[HOME].
 - "DELETE?" is displayed.
 4. Push [ENT]/[SET].
 5. Push [CLR]/[HOME] twice to exit the Set mode.

Using a wired headset

Connect your headset through the optional OPC-2401 headset adapter.

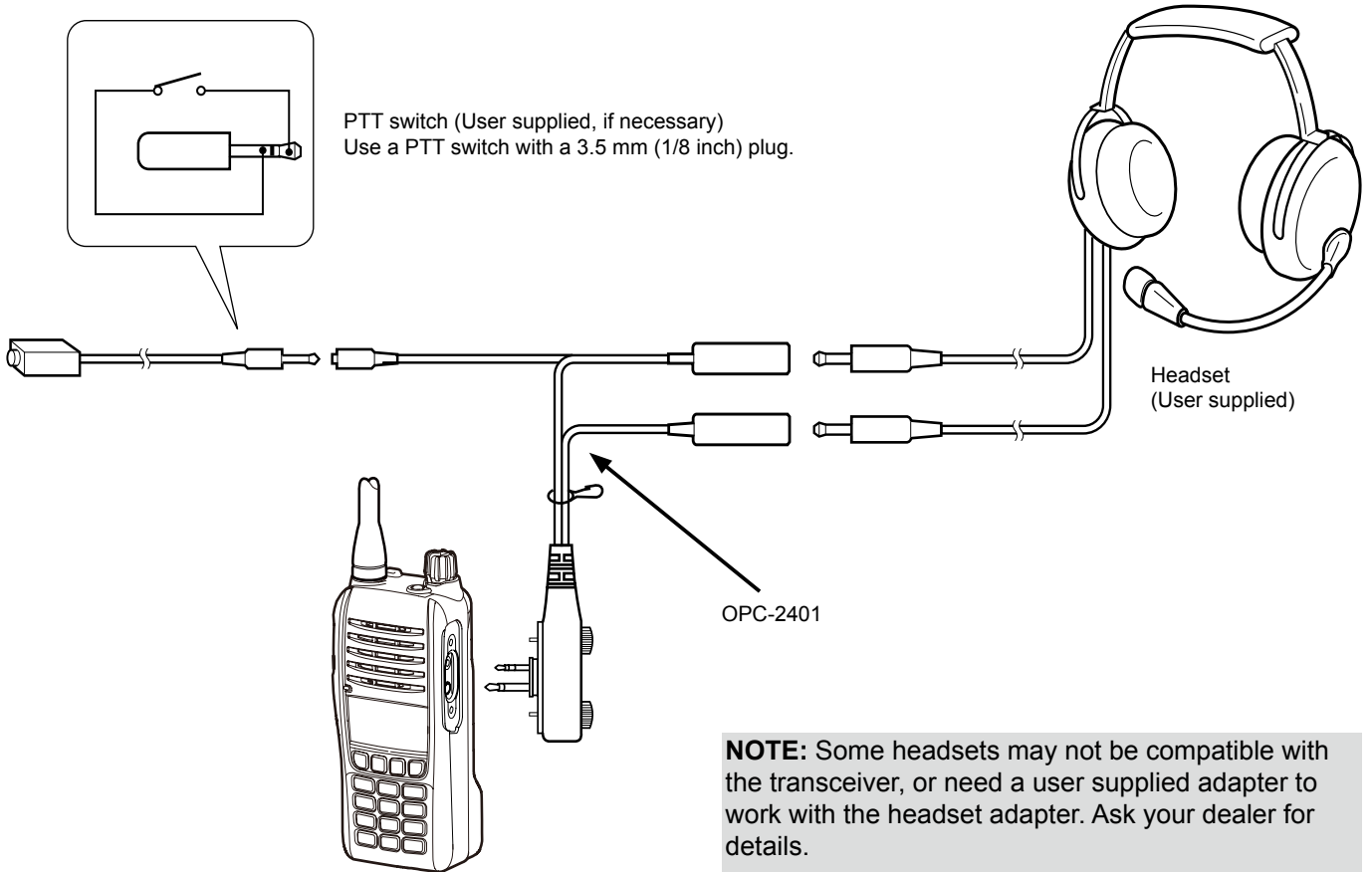

NOTE: Some headsets may not be compatible with the transceiver, or need a user supplied adapter to work with the headset adapter. Ask your dealer for details.

Using the Set mode

You can use the Set mode to set infrequently changed values or function settings.

1. Push [FUNC], and then hold down [ENT]/[SET] for 1 second.
 - ① Set mode item is displayed.
2. Push [MR]/[MW] to select an item.
 - ① Push [ENT]/[SET] to go to the next tree level, go back a level by pushing [CLR]/[HOME].
3. Push [▲] or [▼] to select an option.
4. Push [CLR]/[HOME] to exit the Set mode.

Set mode items

NOTE: The Set mode items contained in the transceiver may be different, depending on the transceiver's version or presets.

■ Backlight “LIT”

Selects the backlight options.

- OFF: The backlight is OFF.
- ON: The backlight is always ON.
- AUTO: The backlight is ON for 5 seconds when a key other than [PTT] is pushed.

■ MIC gain “MIC”

Select a MIC gain option from H (High), M (Medium), or L (Low).

■ MIC Audio Input “MIN”

Select a microphone to input the audio.

- AUTO: Transmit the audio from the device whose [PTT] is pushed.
- INT: Transmit the audio from the internal microphone.
- EXT: Transmit the audio from the external microphone.
- BT*: Transmit the audio from the Bluetooth headset.

*For only the transceiver with built-in Bluetooth unit.

■ VOX setting “VOX”

Turn the VOX function ON or OFF.

The function automatically switches between receive and transmit by detecting your voice.

- OFF: Turns OFF the function.
- ON: Switches between receive and transmit by detecting your voice.

■ VOX Level “VOXL”

Set the VOX gain level to between 1 and 6.

Higher values make the VOX function more sensitive to your voice.

■ VOX delay “VOXD”

Set the VOX Delay to between 0.5 seconds and 3.0 seconds. The VOX Delay is the amount of time that the transmitter stays ON after you stop speaking, until the VOX switches to receive.

■ Time Out Timer “TOT”

Turn the Time Out Timer (TOT) function ON or OFF. This function limits continuous transmissions on the channel, to prevent from occupying the channel for a long period of time.

- OFF: Turns OFF the function.
- 20 to 180: Set the Time-out Timer to between 20 seconds and 180 seconds.

■ Battery voltage “BATT”

Displays the battery voltage.

Set mode items (Continued)

■ Bluetooth settings “BT SET”

(For only the transceiver with built-in Bluetooth unit)

◇ Bluetooth “BT”

Turn the Bluetooth function ON or OFF.

- OFF: Turns OFF the function.
- ON: Turns ON the function.

◇ Auto connect “AT”

Select whether or not to automatically connect to the last bonded Bluetooth device.

- OFF: The user must manually connect to the bonded device.
- ON: Automatically connects to the last bonded device.

◇ Connect/Disconnect

“CONNECT” / “DISCON”

Select this item, and then push [ENT]/[SET] to connect or disconnect a Bluetooth headset.

◇ Pairing “PAIRING”

Select this item, and then push [ENT]/[SET] to pair the Bluetooth headset.

◇ Headset settings “HSET”

○SCO “SCO”

Select an audio connection option.

- AUTO: Connects only when receiving or transmitting audio.
Select this option to share a Bluetooth headset with the transceiver and other devices.
- ALWS: Always connect the audio.

○SP Output “SP”

Select whether or not to output audio from the internal speaker or wired headset when the Bluetooth headset is connected.

- OFF: Output audio from the Bluetooth headset.
- ON: Output audio from the internal speaker, wired headset, and the Bluetooth headset.

○Icom headset “ICOM HS”

Power save “PSAV”:

Select whether or not to operate in the Bluetooth headset’s battery saving mode while the optional VS-3 Bluetooth® HEADSET is connected.

- OFF: The Power Save mode is OFF.
- ON: The Power Save mode is activated when there is no communication or operation for 120 seconds.

PTT “PTT”:

Set the One-Touch PTT function while the optional VS-3 Bluetooth® HEADSET is connected.

The function enables you to communicate with a single push of the VS-3’s [PTT].

- PUSH: Push [PTT] to transmit and release to receive.
- HOLD: Push [PTT] to transmit and push again to receive.

PTT Beep “PTTB”:

Set the beep sound when pushing [PTT] on the optional VS-3 Bluetooth® HEADSET.

- OFF: No beep sounds when pushing PTT.
- ON: A beep sounds when pushing PTT.

◇ Initialize Bluetooth unit “INIT BT”

Initialize the built-in Bluetooth unit.

- ① “INIT BT?” is displayed for confirmation. Push [ENT]/[SET] to initialize.

■ CPU version “CPU”

Displays your transceiver’s firmware version.

■ Bluetooth unit version “BT”

(For only the transceiver with built-in Bluetooth unit)

Displays your transceiver’s built-in Bluetooth unit version.

10 SPECIFICATIONS AND OPTIONS

Specifications (Measurements made without an antenna.)

① All stated specifications are subject to change without notice or obligation.

◇ General

• Frequency range:	IC-A16	TX	118.000 ~ 136.99166 MHz
		RX	108.000 ~ 136.99166 MHz
		WX	161.650 ~ 163.275 MHz
	IC-A16E	TX/RX	118.000 ~ 136.99166 MHz
• Channel spacing:			25 kHz/8.33 kHz
• Mode:	IC-A16		6K00A3E/5K60A3E 16K0G3E (WX)
	IC-A16E		6K80A3E/5K00A3E
• Number of Memory channels:			200 Channels
• Antenna impedance:			50 Ω nominal
• Antenna connector:			BNC type
• Power supply requirement:			7.2 V DC standard
• Current drain:			Less than 1.8 A
• Operating temperature range:	IC-A16		-10°C ~ +60°C, 14°F ~ 140°F
	IC-A16E		-20°C ~ +55°C
• Dimensions*1:			52.2 (W) × 111.8 (H) × 34.1 (D) mm, 2.1 (W) × 4.4 (H) × 1.3 (D) inches
• Weight (approximate):			257 g, 9.1 oz with BP-280

◇ Transmitter

• Output power:			6.0 W (PEP), 1.8 W (CW)
• SAR 10g:			0.37 W/kg
• Modulation limiting (IC-A16):			70 ~ 100%
• Modulation depth (IC-A16E):			85%
• Audio harmonic distortion:	IC-A16		Less than 10% (at 60% modulation)
	IC-A16E		Less than 10% (at 85% + 3dB modulation)
• Ham and Noise ratio:			More than 35 dB
• Spurious emissions:	IC-A16		More than 46 dB*2*3
	IC-A16E		Less than -36 dBm*4
• Frequency stability:	IC-A16		±0.4 kHz
	IC-A16E		±1 ppm

◇ Receiver

• Receive system:			Double conversion superheterodyne
• Intermediate frequencies:			1st 46.35 MHz, 2nd 450 kHz
• Sensitivity:	IC-A16	COM	Less than 0 dBμ (at 6 dB S/N)
		NAV	Less than 3 dBμ (at 6 dB S/N)
		WX	Less than -8 dBμ (at 12 dB SINAD)
	IC-A16E		Less than 0 dBμ (at 12 dB SINAD with CCITT)
• Squelch sensitivity (Threshold):		COM/NAV	Less than 0 dBμ
		WX	Less than -5 dBμ
• Spurious response rejection ratio:	IC-A16	COM/NAV	More than 60 dB
		WX	More than 30 dB
	IC-A16E		More than 70 dB
Audio output power (At 10% distortion):	Int. SP		1500 mW (Typical) into an 8 Ω load
	Ext. SP		More than 350 mW into an 8 Ω load

*1 Projections not included.

*2 Except for the operating frequency ±62.5 kHz in 25 kHz channel spacing.

*3 Except for the operating frequency ±20.825 kHz in 8.33 kHz channel spacing.

*4 Except for the operating frequency ±1 MHz.

Options

◇ Battery packs

- **BP-278/BP-279/BP-280** BATTERY PACKS

Battery pack	Voltage	Capacity
BP-278	7.2 V	1130 mAh (minimum) 1190 mAh (typical)
BP-279	7.2 V	1485 mAh (minimum) 1570 mAh (typical)
BP-280	7.2 V	2280 mAh (minimum) 2400 mAh (typical)

◇ Chargers/Adapters/DC cables

- **BC-213** DESKTOP CHARGER + **BC-123S** AC ADAPTER
To rapidly charge a single battery pack.
- **BC-214** MULTI CHARGER + **BC-157S** AC ADAPTER+ **AD-130** CHARGER ADAPTER
To rapidly charge up to 6 battery packs.
- **CP-23L** CIGARETTE LIGHTER CABLE
Used when charging the battery pack from a 12 V cigarette lighter socket. (Use with the BC-213)
- **OPC-515L** DC POWER CABLE
Used when charging battery packs using a 13.8 V DC power source instead of the power adapter. (Use with the BC-213)
- **OPC-656** DC POWER CABLE
Used with a 13.8 V power source instead of the power adapter. (Use with the BC-214)

◇ Others

- **FA-B02AR** ANTENNA
- **OPC-2401** HEADSET ADAPTER
To connect a wired headset to the transceiver.
- **HM-240** SPEAKER MICROPHONE
- **MB-130** CHARGER BRACKET
Mounts the BC-213 desktop charger on a variety of places in a vehicle.
- **MB-133** BELT CLIP
- **MB-96F/MB-96FL/MB-96N** BELT HANGERS
- **VS-3** Bluetooth® HEADSET
The Bluetooth headset with a [PTT] switch.

About the third party Bluetooth headsets:

Icom has checked the PTT operation with some 3M Peltor headsets, such as the WS Headset XP, WS ProTac XP and WS Alert XP. (Compatibility not guaranteed.)

Some options may not be available in some countries. Ask your dealer for details.

All options and those specifications are subject to change without notice or obligation.

11 TROUBLESHOOTING

Troubleshooting

PROBLEM	POSSIBLE CAUSE	SOLUTION	REF.
The transceiver does not turn ON.	<ul style="list-style-type: none"> The battery is exhausted. The battery pack is not correctly attached. The CP-23L's fuse is blown. 	<ul style="list-style-type: none"> Recharge the battery pack. Correctly reattach the battery pack. Repair the problem, and then replace the fuse. 	<p>p. 6</p> <p>p. 2</p> <p>p. 18</p>
Little or no sound comes from the speaker.	<ul style="list-style-type: none"> Squelch level is set too high. Volume level is set too low. 	<ul style="list-style-type: none"> Adjust the squelch level. Adjust the volume level. 	<p>p. 4</p> <p>p. 4</p>
You cannot transmit.	<ul style="list-style-type: none"> NAV band frequency is set. Weather channel or other non-transmittable channel is selected. No frequency is entered into the selected channel. The battery is exhausted. 	<ul style="list-style-type: none"> Set a COM band frequency. Select a transmittable channel. Enter a frequency into the Memory channel. Recharge the battery pack. 	<p>p. 7</p> <p>p. 7</p> <p>p. 9</p> <p>p. 6</p>
You cannot use the keypad to enter the frequency or select the memory channel.	<ul style="list-style-type: none"> The keypad is locked. 	<ul style="list-style-type: none"> Hold down [↵] for 2 seconds to unlock the keypad. 	<p>p. 4</p>
Scan does not start.	<ul style="list-style-type: none"> No Memory channels in the selected group are tagged. The squelch is open. Nothing is entered in the Memory channels. 	<ul style="list-style-type: none"> Tag memory channels. Adjust the squelch level. Enter frequencies into the Memory channels. 	<p>p. 8</p> <p>p. 4</p> <p>p. 9</p>
No beep sounds.	<ul style="list-style-type: none"> The Key beep is set to OFF. The audio output level is low. 	<ul style="list-style-type: none"> Push [FUNC], and then push [8]/[BEEP] to turn ON the beep. Rotate [VOL] to adjust the audio output level. 	<p>p. 4</p> <p>p. 4</p>

◇ Fuse replacement

If the fuse blows or the transceiver stop working when using the optional CP-23L CIGARETTE LIGHTER CABLE, correct the source of the problem. Then replace the damaged fuse with a new rated one (FGB 4 A), as shown to the right.

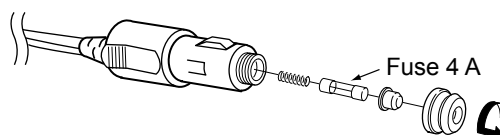

INDEX

	A	
Accessories, supplied		1
Auto connect.....		15
Automatic noise limiter		7
	B	
Backlight.....		14
Battery charging		6
Bluetooth headset		
Bluetooth settings.....		15
Disconnecting.....		12
Electromagnetic Interference		12
Pairing		12
Unpairing		12
	C	
CPU version		15
	E	
Emergency frequency.....		7
	F	
Front panel		4
Function display.....		5
	H	
Headset settings.....		15
Home function		11
	K	
Key beep		4
Keypad lock.....		4
	M	
Memory channel		
Copying		10
Deleting		10
Editing		9
Entering.....		9
	O	
One-Touch PTT		15
Options		17
	P	
Power save.....		15
PTT Beep		15
	R	
Receiving.....		7
	S	
Scan types.....		8
Set mode, using.....		14
Side tone		11
Speaker output		15
Squelch.....		4
	T	
Time out timer.....		14
Transmitting.....		7
	V	
Volume.....		4
	W	
Wired headset connection		13

Count on us!

